



Juno Wafer™ LED Downlight Series

4" & 6" SWW5 + ALO LED Flat & Deep Regressed Wafers

Project:
Fixture Type:
Location:
Contact/Phone:

WF4 & WF6 SWW5 + ALO Series

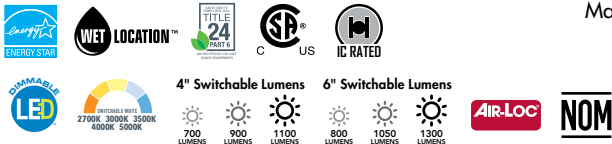
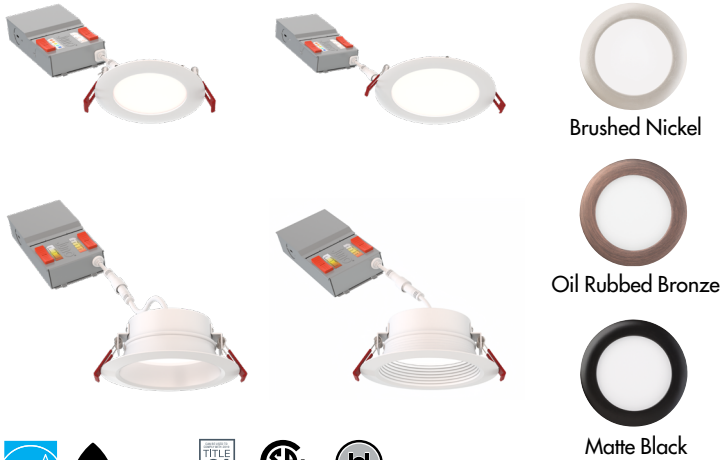

Product Features

The 4" & 6" flat and deep regressed with 5CCT Switchable White and ALO technology wafers provide high-quality light output and efficiency while delivering industry leading technology and functionality without the need for a recessed housing.

- Next-generation optical technology and design enable precise, even illumination where needed
- Canless - no can required; equals easy to install and less labor
- With selectable color temperatures ranging from warm (2700K) to daylight (5000K), getting the right look for your space is a breeze
- 3 ALO settings allow you to get the perfect amount of light in your space

Applications

- Residential and light commercial applications including multi-family, hospitality, assisted living, dormitories and other multi-level construction
- Streamlined profile allows for easy remodel or new construction in both insulated and drop ceiling installations
- Wet rated and airtight: perfect for showers, bathrooms, and covered outdoor soffits

Dimensions

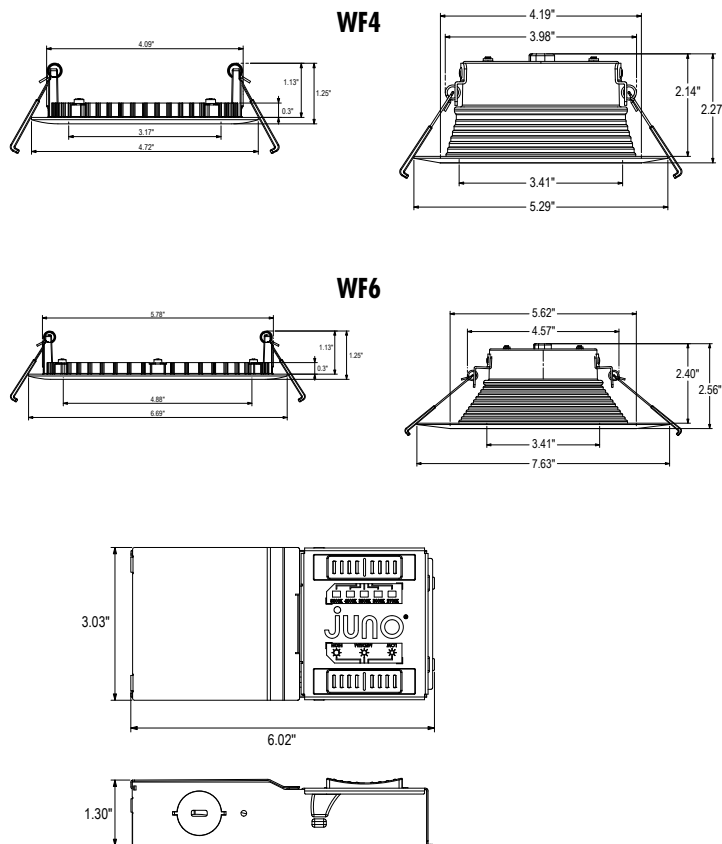

Performance

Delivered Lumens	4" - 700/900/1100 6" - 800/1050/1300
LED Color Temperature	Switchable White (27K, 30K, 35K, 40K, 50K) Default set at 3000K
CRI	90+
Voltage	Dedicated 120V and MVOLT
Dimming	Dimmable to 10% with triac or 0-10v dimmers

For a list of compatible dimmers see [JUNO-WAFERS-DIM](#)

Specifications

	FLAT		DREG	
	WF4	WF6	WF4	WF6
Aperture:	3.17"	4.88"	3.41"	3.41"
Ceiling Opening:	4.25"	6.25"	4.25"	6.25"
Overlap Trim:	4.72"	6.69"	5.29"	7.63"
Height:	1.25"	1.25"	2.27"	2.56"



Juno Wafer™ LED Downlight Series

4" & 6" SWW5 + ALO LED Flat & Deep Regressed Wafers

ORDERING INFORMATION

Flat Wafer

Example: WF4 ALO19 SWW5 90CRI MW

Series	Trim Designation	Lumens	Color Temperature	Rendering Index	Voltage	Finish
WF4 4" Wafer Led Downlight	(BLANK) Flat	ALO19 ¹ Switchable lumens – 700LM, 1000LM, and 1100LM	SWW5 Switchable CCT – 2700K, 3000K, 3500K, 4000K, and 5000K	90CRI 90+ CRI	(BLANK) 120V MVOLT Multi-Volt (120-277)	MW Matte White MB Matte Black BN Brushed Nickel ORB Oil Rubbed Bronze
WF6 6" Wafer Led Downlight		ALO20 ² Switchable lumens – 800LM, 1050LM, and 1300LM				

Deep Regressed Wafer

Example: WF6 DREG B ALO20 SWW5 90CRI MW

Series	Trim Designation	Trim Style	Lumens	Color Temperature	Rendering Index	Voltage	Finish ³
WF4 4" Wafer Led Downlight	DREG Deep Regressed	B Baffle	ALO19 ¹ Switchable lumens – 700LM, 1000LM, and 1100LM	SWW5 Switchable CCT – 2700K, 3000K, 3500K, 4000K, and 5000K	90CRI 90+ CRI	(BLANK) 120V	MW Matte White
WF6 6" Wafer Led Downlight		SM Smooth	ALO20 ² Switchable lumens – 800LM, 1050LM, and 1300LM				

1. Only available with WF4.
2. Only available with WF6.
3. For additional finishes see [trim insert](#) offerings.

Accessories: Order as separate catalog number.

Series	
WF8643 PAN R6	Universal New Construction Pan, Retail Pack of 6
WF8643 PAN U	Universal New Construction Pan, Unit Pack
WF4 PAN R12	4" New construction pan, retail pack of 12
WF4GR MW JZ	4" Wafer Goof Ring 4.2" ID x 6.2" OD
WF6 PAN R12	6" New construction pan, retail pack of 12
WF6GR MW JZ	6" Wafer Goof Ring 6" ID x 8" OD
WFJB U	Remodel Joist Bar
WFEXC6 SW3PIN FT4	3-Pin 6ft Cable
WFEXC10 SW3PIN FT4	3-Pin 10ft Cable
WFEXC20 SW3PIN FT4	3-Pin 20ft Cable



WF8643 UNIVERSAL New Construction Pan



WF4 PAN 4" New Construction Pan



Remodel Joist Bar



WFEXC_ 3-Pin Extension Cable



WF6 PAN 6" New Construction Pan

*Goof rings are made of 22 gauge steel and painted white.

PERFORMANCE DATA

	WF4 (DREG) ALO19 SWW5			WF6 (DREG) ALO20 SWW5		
	High	Medium	Low	High	Medium	Low
Input Power Typical	14.5W (+/-5%)	11.75(+/-5%)	8.56(+/-5%)	14.5W (+/-5%)	11.75(+/-5%)	8.56(+/-5%)
Input Voltage	120V			120V		
Frequency	60 Hz			60 Hz		
EMI/RFI	FCC Title 47, Part 15 Class B (consumer)			FCC Title 47, Part 15 Class B (consumer)		
Minimum Starting Temp	-40°F (-40°C)			-40°F (-40°C)		

Note: Actual performance may differ as a result of end-user environment and application. All values are design or typical values, measured under laboratory conditions at 25°C.



Juno Wafer™ LED Downlight Series

4" & 6" SWW5 + ALO LED Flat & Deep Regressed Wafers

TRIM INSERTS

TRIM INSERTS (for field configuration; ordered separately)

Example: 4BEMB R4

Series/Finish		Packaging	
4BEMB	4" Baffle, Matte Black	4SEMB	4" Smooth, Matte Black
4BEBN	4" Baffle, Brush Nickel	4SEBN	4" Smooth, Brush Nickel
4BEORB	4" Baffle, Oil-Rubbed Bronze	4SEORB	4" Smooth, Oil-Rubbed Bronze
		R4	Retail Pack of 4 units



4" Baffle, Matte Black (4BEMB)



4" Baffle, Brush Nickel (4BEBN)



4" Baffle, Oil-Rubbed Bronze (4BEORB)



4" Smooth, Matte Black (4SEMB)



4" Smooth, Brush Nickel (4SEBN)



4" Smooth, Oil-Rubbed Bronze (4SEORB)



Pre-Install color finish trim insert over white 4" or 6" Wafer LED Downlight.



Press down color finish tabs for post-installation to create final Wafer LED Downlight.

TRIM INSERTS

TRIM INSERTS (for field configuration; ordered separately)

Example: 6SSEBN R4

Series/Finish		Packaging	
6SBEMB	6" Baffle, Matte Black	6SSEMB	6" Smooth, Matte Black
6SBEBN	6" Baffle, Matte Nickel	6SSEBN	6" Smooth, Brush Nickel
6SBEORB	6" Baffle, Oil-Rubbed Bronze	6SSEORB	6" Smooth, Oil-Rubbed Bronze
		R4	Retail Pack of 4 units

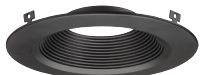

6" Baffle, Matte Black (6SBEMB)

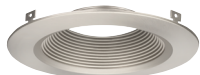

6" Baffle, Brush Nickel (6SBEBN)

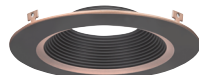

6" Baffle, Oil-Rubbed Bronze (6SBEORB)



6" Smooth, Matte Black (6SSEMB)



6" Smooth, Brush Nickel (6SSEBN)



6" Smooth, Oil-Rubbed Bronze (6SSEORB)



Juno Wafer™ LED Downlight Series

4" & 6" SWW5 + ALO LED Flat & Deep Regressed Wafers

Specifications

Housing

Aluminum die cast outer frame. Durable, powder coat paint to prevent rust

- FT4 3-pin plenum rated cable connector to connect from module to remote driver box
- Steel spring clip for easy installation. 4" or 6" cut out template is provided to ensure a correct sized hole is cut into ceiling for proper installation of the trim. Size of hole should not exceed 4-1/4" for the WF4 and 6-1/4" for the WF6
- Can be installed from 3/8" to 1 1/2" ceiling thickness
- Can be removed from below the ceiling for service or replacement.

LED Light Engine

Low/Medium/High lumen output settings and choice of 2700K, 3000K, 3500K, 4000K or 5000K color temperatures

- 90 CRI minimum
- Color accuracy within 4 step MacAdams Ellipse at the end CCT (2700K and 5000K), within 6 step MacAdams Ellipse in the middle CCT (3000K, 3500K, and 4000K)
- Dimming 100% to 10% with most standard incandescent dimers (see list of approved dimmers).

Driver

Connect directly to 120V Class-2 (CAN ICES-005 (B) / NMB-005 (B)) LED driver

- 120V 60 Hz constant current driver provides noise free operation
- IC rated driver with convenience of a switch to choose between 5 selectable color temperature options ranging from 2700K (warm white), 3000K, 3500K, 4000K, or 5000K (daylight)
- The isolated driver integrated inside steel remote box with four 7/8" knockouts with slots for pryout. Suitable for pulling wires with the 12 cubic-inch wiring compartment to accommodate up to (6) 14 gauge insulated conductor or (4) 12 gauge insulated conductors, making the Wafer LED Downlights much easier to wire in 2in/2out (plus ground) daisy-chain applications and contractor friendly
- 2" plenum space required for the installation of the WF6 driver box; 3" plenum space required for the installation of the WF4 driver box
- Suitable for installation in t-grid and drop ceiling applications with universal new construction pan.

Electrical

Multi-volt (120-277V, 50/60Hz) proprietary remote LED driver/splice box, with two (2) additional low-voltage wires for 0-10v dimming, down to 10% (depending on dimmer model and application). High efficient driver with power factor > 0.9. Ambient operating temperature: -40°F (-40°C) to +104°F (+40°C).

Optical System

Both edge-lit and back-lit technologies are used to distribute light

- Polycarbonate lens provides even illumination throughout the space
- Efficient system that can produce over 1100 lumens while using 14.5W with the WF4 and over 1300 lumens while using 16W with the WF6
- Replaces 65W incandescent (WF4) and 75W incandescent (WF6).

Life

Rated for 50,000 hours at 70% lumen maintenance.

Labels

CSA certified to US and Canadian safety standards

- ENERGY STAR® certified product
- Suitable for wet location, covered ceiling
- Air-Loc certified in accordance with ASTM E283-2004
- NOM Certified
- Can be used to comply with California Title 24 Part 6 High Efficacy LED light Source Requirements
- U.S. Patent No. 10,681,784.

Testing

All reports are based on published industry procedures; field performance may differ from laboratory performance.

Warranty

3-year limited warranty. This is the only warranty provided and no other statements in this specification sheet create any warranty of any kind. All other express and implied warranties are disclaimed. Complete warranty terms located at: www.acuitybrands.com/support/warranty/terms-and-conditions

Note: Actual performance may differ as a result of end-user environment and application.

All values are design or typical values, measured under laboratory conditions at 25 °C.

Specifications subject to change without notice.



Juno Wafer™ LED Downlight Series

4" & 6" SWW5 + ALO LED Flat & Deep Regressed Wafers

PHOTOMETRICS

Distribution Curve

Distribution Data

Output Data

Coefficient of Utilization

Illuminance Data at 30" Above Floor for a Single Luminaire

Lumen Multiplier			
	LOW	MEDIUM	HIGH
120V	0.65	0.85	1.00
MVOLT	0.58	0.84	1.00

WF4 ALO19 SWW5 90CRI 27K-HI Input Watts: 13.5, Delivered Lumens: 980, LPW: 72.6, S/MH: 1.27, Test No: ISF 232959P1

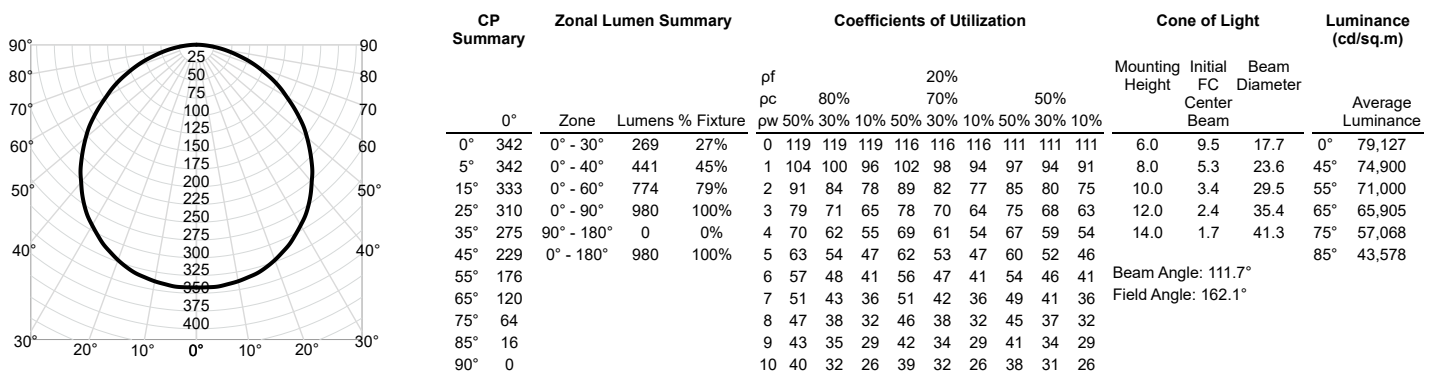

WF4 ALO19 SWW5 90CRI 30K-HI Input Watts: 13.5, Delivered Lumens: 1048, LPW: 77.6, S/MH: 1.27, Test No: ISF 232959P2

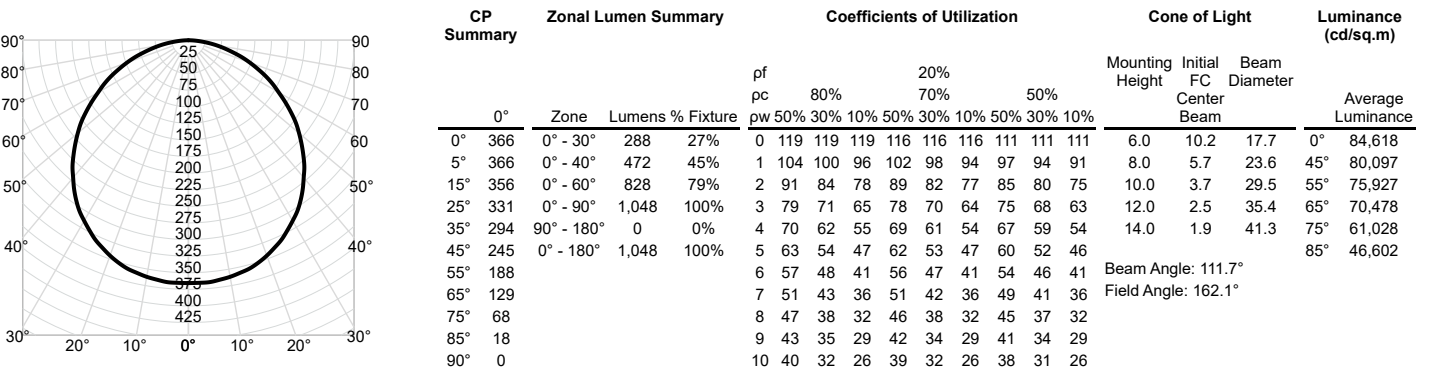

WF4 ALO19 SWW5 90CRI 35K-HI Input Watts: 13.5, Delivered Lumens: 1107, LPW: 82.0, S/MH: 1.27, Test No: ISF 232959P3

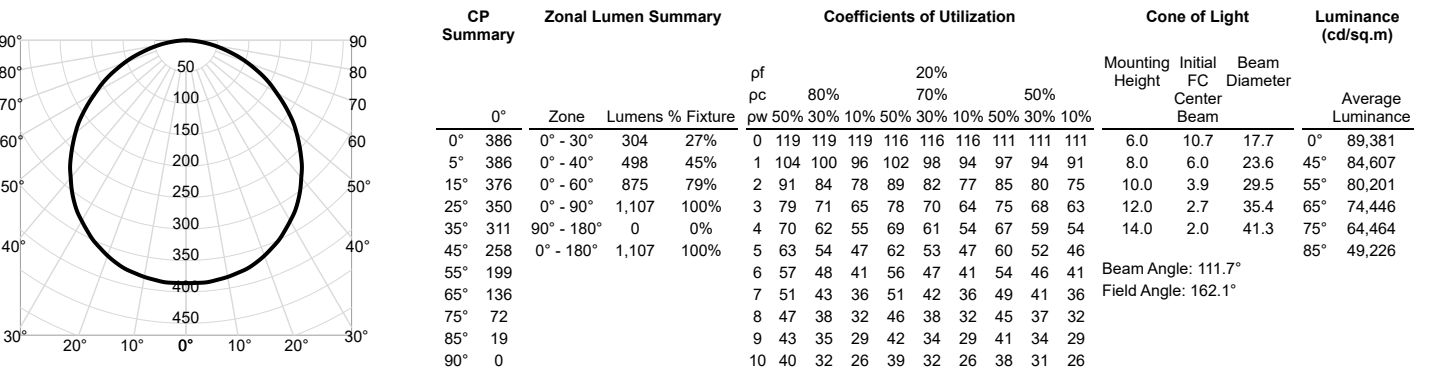



Juno Wafer™ LED Downlight Series

4" & 6" SWW5 + ALO LED Flat & Deep Regressed Wafers

PHOTOMETRICS

Distribution Curve

Distribution Data

Output Data

Coefficient of Utilization

Illuminance Data at 30" Above Floor for a Single Luminaire

WF4 ALO19 SWW5 90CRI 40K-HI Input Watts: 13.5, Delivered Lumens: 1124, LPW: 83.3, S/MH: 1.27, Test No: ISF 232959P4

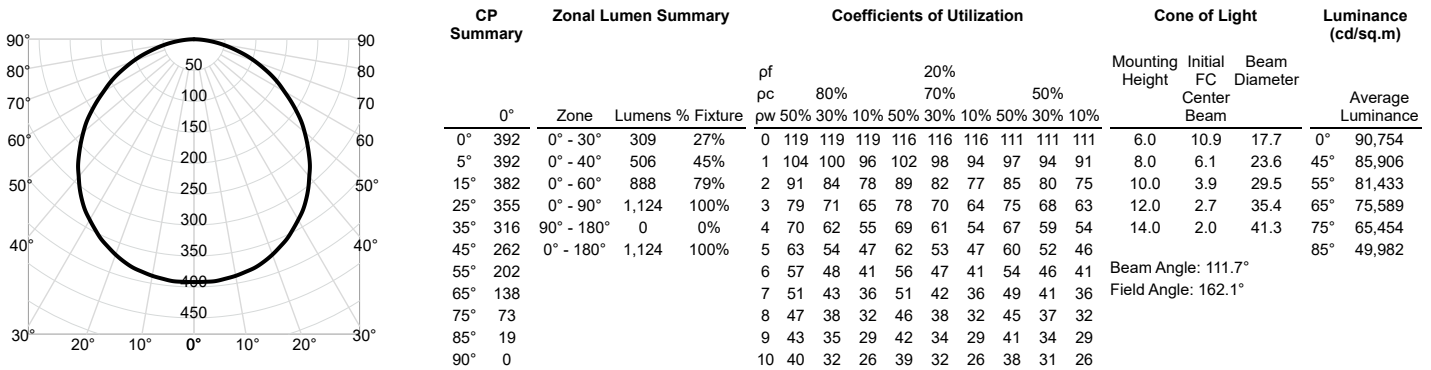

WF4 ALO19 SWW5 90CRI 50K-HI Input Watts: 13.5, Delivered Lumens: 1080, LPW: 80.0, S/MH: 1.27, Test No: ISF 232959P5

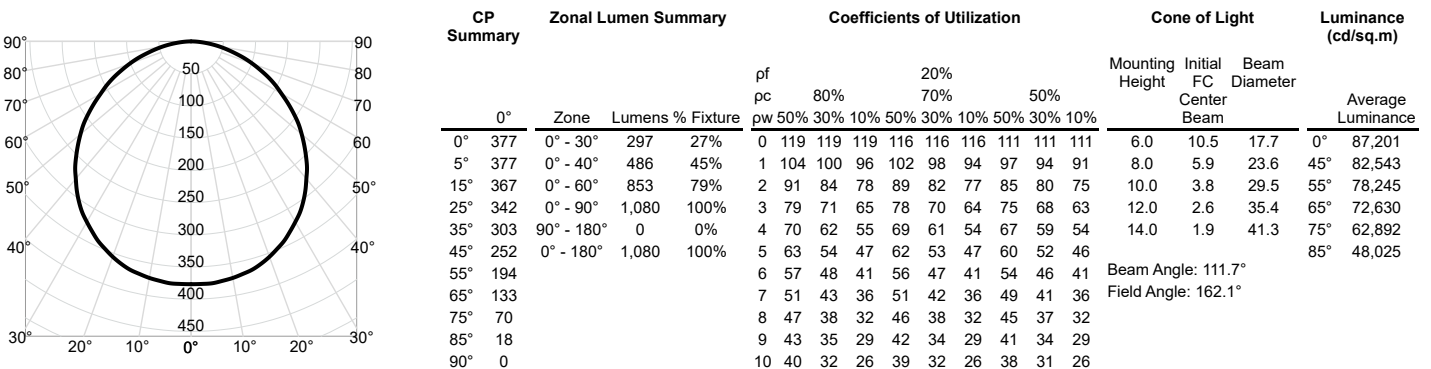

WF4 DREG B ALO19 SWW5 90CRI 27K-HI Input Watts: 12.5, Delivered Lumens: 1019, LPW: 81.5, S/MH: 1.19, Test No: ISF 232976P6

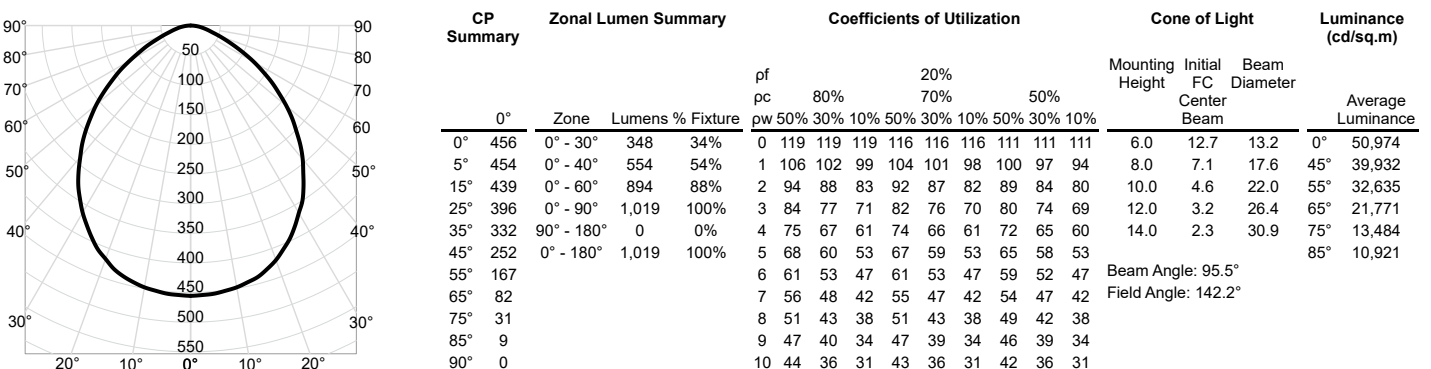



Juno Wafer™ LED Downlight Series

4" & 6" SWW5 + ALO LED Flat & Deep Regressed Wafers

PHOTOMETRICS

Distribution Curve

Distribution Data

Output Data

Coefficient of Utilization

Illuminance Data at 30" Above Floor for a Single Luminaire

WF4 DREG B ALO19 SWW5 90CRI 30K-HI Input Watts: 12.5, Delivered Lumens: 1074, LPW: 85.9, S/MH: 1.19, Test No: ISF 232976P7

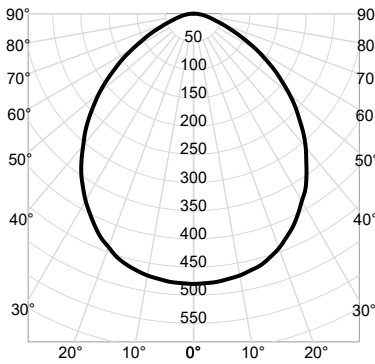

CP Summary		Zonal Lumen Summary		Coefficients of Utilization								Cone of Light			Luminance (cd/sq.m)			
0°	Zone	Lumens	% Fixture	pw	80%		20%		50%		Mounting Height	Initial FC Center Beam	Beam Diameter	Average Luminance				
					50%	30%	10%	50%	30%	10%					50%	30%	10%	
0°	0° - 30°	367	34%	0	119	119	119	116	116	116	111	111	111	6.0	13.3	13.2	0°	53,725
5°	0° - 40°	584	54%	1	106	102	99	104	101	98	100	97	94	8.0	7.5	17.6	45°	42,088
15°	0° - 60°	942	88%	2	94	88	83	92	87	82	89	84	80	10.0	4.8	22.0	55°	34,396
25°	0° - 90°	1,074	100%	3	84	77	71	82	76	70	80	74	69	12.0	3.3	26.4	65°	22,946
35°	90° - 180°	0	0%	4	75	67	61	74	66	61	72	65	60	14.0	2.5	30.9	75°	14,212
45°	0° - 180°	1,074	100%	5	68	60	53	67	59	53	65	58	53				85°	11,510
55°		176		6	61	53	47	61	53	47	59	52	47	Beam Angle: 95.5°				
65°		87		7	56	48	42	55	47	42	54	47	42	Field Angle: 142.2°				
75°		33		8	51	43	38	51	43	38	49	42	38					
85°		9		9	47	40	34	47	39	34	46	39	34					
90°		0		10	44	36	31	43	36	31	42	36	31					

WF4 DREG B ALO19 SWW5 90CRI 35K-HI Input Watts: 12.5, Delivered Lumens: 1136, LPW: 90.9, S/MH: 1.19, Test No: ISF 232976P8

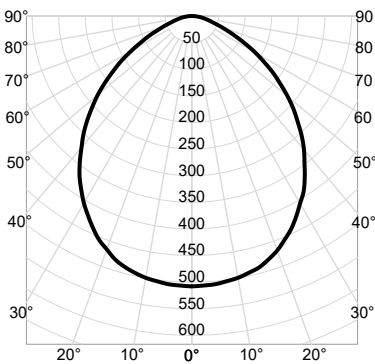

CP Summary		Zonal Lumen Summary		Coefficients of Utilization								Cone of Light			Luminance (cd/sq.m)			
0°	Zone	Lumens	% Fixture	pw	80%		20%		50%		Mounting Height	Initial FC Center Beam	Beam Diameter	Average Luminance				
					50%	30%	10%	50%	30%	10%					50%	30%	10%	
0°	0° - 30°	388	34%	0	119	119	119	116	116	116	111	111	111	6.0	14.1	13.2	0°	56,826
5°	0° - 40°	618	54%	1	106	102	99	104	101	98	100	97	94	8.0	7.9	17.6	45°	44,517
15°	0° - 60°	997	88%	2	94	88	83	92	87	82	89	84	80	10.0	5.1	22.0	55°	36,382
25°	0° - 90°	1,136	100%	3	84	77	71	82	76	70	80	74	69	12.0	3.5	26.4	65°	24,270
35°	90° - 180°	0	0%	4	75	67	61	74	66	61	72	65	60	14.0	2.6	30.9	75°	15,032
45°	0° - 180°	1,136	100%	5	68	60	53	67	59	53	65	58	53				85°	12,174
55°		187		6	61	53	47	61	53	47	59	52	47	Beam Angle: 95.5°				
65°		92		7	56	48	42	55	47	42	54	47	42	Field Angle: 142.2°				
75°		35		8	51	43	38	51	43	38	49	42	38					
85°		9		9	47	40	34	47	39	34	46	39	34					
90°		0		10	44	36	31	43	36	31	42	36	31					

WF4 DREG B ALO19 SWW5 90CRI 40K-HI Input Watts: 12.5, Delivered Lumens: 1148, LPW: 91.8, S/MH: 1.19, Test No: ISF 232976P9

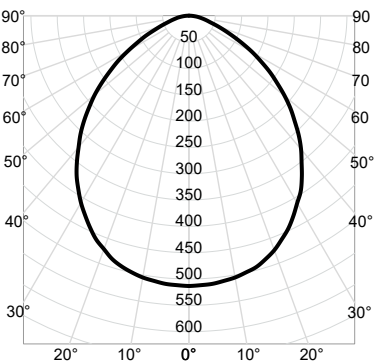

CP Summary		Zonal Lumen Summary		Coefficients of Utilization								Cone of Light			Luminance (cd/sq.m)			
0°	Zone	Lumens	% Fixture	pw	80%		20%		50%		Mounting Height	Initial FC Center Beam	Beam Diameter	Average Luminance				
					50%	30%	10%	50%	30%	10%					50%	30%	10%	
0°	0° - 30°	392	34%	0	119	119	119	116	116	116	111	111	111	6.0	14.3	13.2	0°	57,427
5°	0° - 40°	624	54%	1	106	102	99	104	101	98	100	97	94	8.0	8.0	17.6	45°	44,988
15°	0° - 60°	1,007	88%	2	94	88	83	92	87	82	89	84	80	10.0	5.1	22.0	55°	36,766
25°	0° - 90°	1,148	100%	3	84	77	71	82	76	70	80	74	69	12.0	3.6	26.4	65°	24,527
35°	90° - 180°	0	0%	4	75	67	61	74	66	61	72	65	60	14.0	2.6	30.9	75°	15,191
45°	0° - 180°	1,148	100%	5	68	60	53	67	59	53	65	58	53				85°	12,303
55°		188		6	61	53	47	61	53	47	59	52	47	Beam Angle: 95.5°				
65°		93		7	56	48	42	55	47	42	54	47	42	Field Angle: 142.2°				
75°		35		8	51	43	38	51	43	38	49	42	38					
85°		10		9	47	40	34	47	39	34	46	39	34					
90°		0		10	44	36	31	43	36	31	42	36	31					



Juno Wafer™ LED Downlight Series

4" & 6" SWW5 + ALO LED Flat & Deep Regressed Wafers

PHOTOMETRICS

Distribution Curve

Distribution Data

Output Data

Coefficient of Utilization

Illuminance Data at 30" Above Floor for a Single Luminaire

WF4 DREG B ALO19 SWW5 90CRI 50K-HI Input Watts: 12.5, Delivered Lumens: 1109, LPW: 88.7, S/MH: 1.19, Test No: ISF 232976P10

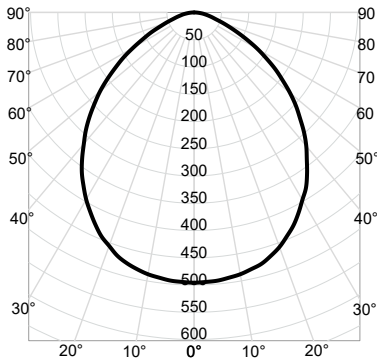

CP Summary	Zonal Lumen Summary				Coefficients of Utilization										Cone of Light			Luminance (cd/sq.m)	
	0°	Zone	Lumens	% Fixture	pf pc	80%		20%		70%		50%		Mounting Height	Initial FC Center Beam	Beam Diameter	Average Luminance		
						50%	30%	10%	50%	30%	10%	50%	30%					10%	
0°	496	0° - 30°	379	34%	0	119	119	119	116	116	116	111	111	111	6.0	13.8	13.2	0°	55,476
5°	494	0° - 40°	603	54%	1	106	102	99	104	101	98	100	97	94	8.0	7.7	17.6	45°	43,459
15°	477	0° - 60°	973	88%	2	94	88	83	92	87	82	89	84	80	10.0	5.0	22.0	55°	35,517
25°	431	0° - 90°	1,109	100%	3	84	77	71	82	76	70	80	74	69	12.0	3.4	26.4	65°	23,693
35°	361	90° - 180°	0	0%	4	75	67	61	74	66	61	72	65	60	14.0	2.5	30.9	75°	14,675
45°	275	0° - 180°	1,109	100%	5	68	60	53	67	59	53	65	58	53	Beam Angle: 95.5°			85°	11,885
55°	182				6	61	53	47	61	53	47	59	52	47	Field Angle: 142.2°				
65°	90				7	56	48	42	55	47	42	54	47	42					
75°	34				8	51	43	38	51	43	38	49	42	38					
85°	9				9	47	40	34	47	39	34	46	39	34					
90°	0				10	44	36	31	43	36	31	42	36	31					

WF4 DREG SM ALO19 SWW5 90CRI 27K Input Watts: 12.5, Delivered Lumens: 1019, LPW: 81.5, S/MH: 1.19, Test No: ISF 232976P1

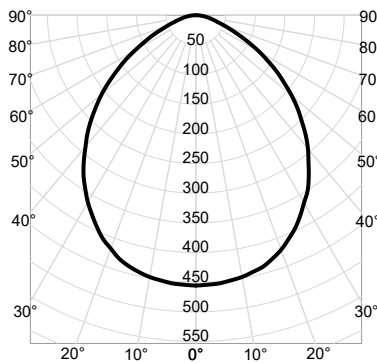

CP Summary	Zonal Lumen Summary				Coefficients of Utilization										Cone of Light			Luminance (cd/sq.m)	
	0°	Zone	Lumens	% Fixture	pf pc	80%		20%		70%		50%		Mounting Height	Initial FC Center Beam	Beam Diameter	Average Luminance		
						50%	30%	10%	50%	30%	10%	50%	30%					10%	
0°	456	0° - 30°	348	34%	0	119	119	119	116	116	116	111	111	111	6.0	12.7	13.2	0°	50,974
5°	454	0° - 40°	554	54%	1	106	102	99	104	101	98	100	97	94	8.0	7.1	17.6	45°	39,932
15°	439	0° - 60°	894	88%	2	94	88	83	92	87	82	89	84	80	10.0	4.6	22.0	55°	32,635
25°	396	0° - 90°	1,019	100%	3	84	77	71	82	76	70	80	74	69	12.0	3.2	26.4	65°	21,771
35°	332	90° - 180°	0	0%	4	75	67	61	74	66	61	72	65	60	14.0	2.3	30.9	75°	13,484
45°	252	0° - 180°	1,019	100%	5	68	60	53	67	59	53	65	58	53	Beam Angle: 95.5°			85°	10,921
55°	167				6	61	53	47	61	53	47	59	52	47	Field Angle: 142.2°				
65°	82				7	56	48	42	55	47	42	54	47	42					
75°	31				8	51	43	38	51	43	38	49	42	38					
85°	9				9	47	40	34	47	39	34	46	39	34					
90°	0				10	44	36	31	43	36	31	42	36	31					

WF4 DREG SM ALO19 SWW5 90CRI 30K Input Watts: 12.5, Delivered Lumens: 1074, LPW: 85.9, S/MH: 1.19, Test No: ISF 232976P2

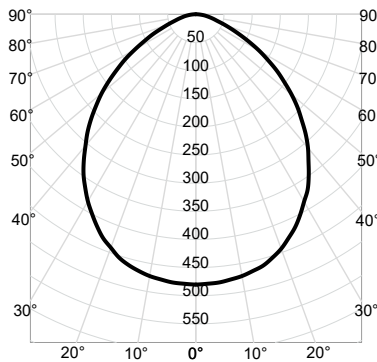

CP Summary	Zonal Lumen Summary				Coefficients of Utilization										Cone of Light			Luminance (cd/sq.m)	
	0°	Zone	Lumens	% Fixture	pf pc	80%		20%		70%		50%		Mounting Height	Initial FC Center Beam	Beam Diameter	Average Luminance		
						50%	30%	10%	50%	30%	10%	50%	30%					10%	
0°	480	0° - 30°	367	34%	0	119	119	119	116	116	116	111	111	111	6.0	13.3	13.2	0°	53,725
5°	478	0° - 40°	584	54%	1	106	102	99	104	101	98	100	97	94	8.0	7.5	17.6	45°	42,088
15°	462	0° - 60°	942	88%	2	94	88	83	92	87	82	89	84	80	10.0	4.8	22.0	55°	34,396
25°	417	0° - 90°	1,074	100%	3	84	77	71	82	76	70	80	74	69	12.0	3.3	26.4	65°	22,946
35°	350	90° - 180°	0	0%	4	75	67	61	74	66	61	72	65	60	14.0	2.5	30.9	75°	14,212
45°	266	0° - 180°	1,074	100%	5	68	60	53	67	59	53	65	58	53	Beam Angle: 95.5°			85°	11,510
55°	176				6	61	53	47	61	53	47	59	52	47	Field Angle: 142.2°				
65°	87				7	56	48	42	55	47	42	54	47	42					
75°	33				8	51	43	38	51	43	38	49	42	38					
85°	9				9	47	40	34	47	39	34	46	39	34					
90°	0				10	44	36	31	43	36	31	42	36	31					



Juno Wafer™ LED Downlight Series

4" & 6" SWW5 + ALO LED Flat & Deep Regressed Wafers

PHOTOMETRICS

Distribution Curve

Distribution Data

Output Data

Coefficient of Utilization

Illuminance Data at 30" Above Floor for a Single Luminaire

WF4 DREG SM ALO19 SWW5 90CRI 35K Input Watts: 12.5, Delivered Lumens: 1136, LPW: 90.9, S/MH: 1.19, Test No: ISF 232976P3

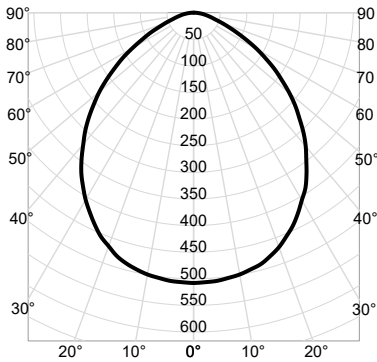

CP Summary		Zonal Lumen Summary		Coefficients of Utilization								Cone of Light			Luminance (cd/sq.m)			
0°	Zone	Lumens	% Fixture	pf pc	80%		20%		50%		Mounting Height	Initial FC Center Beam	Beam Diameter	Average Luminance				
					50%	30%	10%	50%	30%	10%								
0°	0° - 30°	388	34%	0	119	119	119	116	116	116	111	111	111	6.0	14.1	13.2	0°	56,826
5°	0° - 40°	618	54%	1	106	102	99	104	101	98	100	97	94	8.0	7.9	17.6	45°	44,517
15°	0° - 60°	997	88%	2	94	88	83	92	87	82	89	84	80	10.0	5.1	22.0	55°	36,382
25°	0° - 90°	1,136	100%	3	84	77	71	82	76	70	80	74	69	12.0	3.5	26.4	65°	24,270
35°	90° - 180°	0	0%	4	75	67	61	74	66	61	72	65	60	14.0	2.6	30.9	75°	15,032
45°	0° - 180°	1,136	100%	5	68	60	53	67	59	53	65	58	53				85°	12,174
55°				6	61	53	47	61	53	47	59	52	47	Beam Angle: 95.5°				
65°				7	56	48	42	55	47	42	54	47	42	Field Angle: 142.2°				
75°				8	51	43	38	51	43	38	49	42	38					
85°				9	47	40	34	47	39	34	46	39	34					
90°				10	44	36	31	43	36	31	42	36	31					

WF4 DREG SM ALO19 SWW5 90CRI 40K Input Watts: 12.5, Delivered Lumens: 1148, LPW: 91.8, S/MH: 1.19, Test No: ISF 232976P4

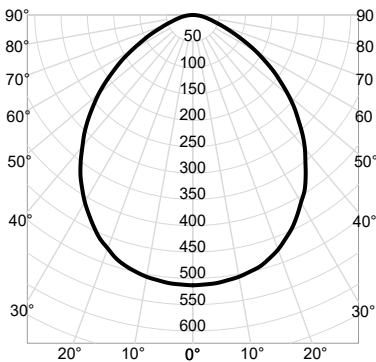

CP Summary		Zonal Lumen Summary		Coefficients of Utilization								Cone of Light			Luminance (cd/sq.m)			
0°	Zone	Lumens	% Fixture	pf pc	80%		20%		50%		Mounting Height	Initial FC Center Beam	Beam Diameter	Average Luminance				
					50%	30%	10%	50%	30%	10%								
0°	0° - 30°	392	34%	0	119	119	119	116	116	116	111	111	111	6.0	14.3	13.2	0°	57,427
5°	0° - 40°	624	54%	1	106	102	99	104	101	98	100	97	94	8.0	8.0	17.6	45°	44,988
15°	0° - 60°	1,007	88%	2	94	88	83	92	87	82	89	84	80	10.0	5.1	22.0	55°	36,766
25°	0° - 90°	1,148	100%	3	84	77	71	82	76	70	80	74	69	12.0	3.6	26.4	65°	24,527
35°	90° - 180°	0	0%	4	75	67	61	74	66	61	72	65	60	14.0	2.6	30.9	75°	15,191
45°	0° - 180°	1,148	100%	5	68	60	53	67	59	53	65	58	53				85°	12,303
55°				6	61	53	47	61	53	47	59	52	47	Beam Angle: 95.5°				
65°				7	56	48	42	55	47	42	54	47	42	Field Angle: 142.2°				
75°				8	51	43	38	51	43	38	49	42	38					
85°				9	47	40	34	47	39	34	46	39	34					
90°				10	44	36	31	43	36	31	42	36	31					

WF4 DREG SM ALO19 SWW5 90CRI 50K Input Watts: 12.5, Delivered Lumens: 1109, LPW: 88.7, S/MH: 1.19, Test No: ISF 232976P5

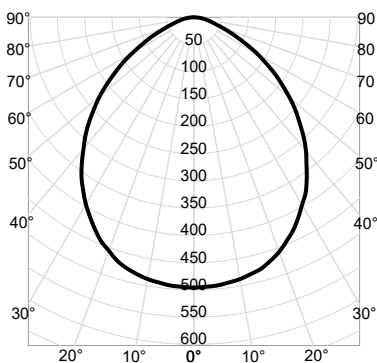

CP Summary		Zonal Lumen Summary		Coefficients of Utilization								Cone of Light			Luminance (cd/sq.m)			
0°	Zone	Lumens	% Fixture	pf pc	80%		20%		50%		Mounting Height	Initial FC Center Beam	Beam Diameter	Average Luminance				
					50%	30%	10%	50%	30%	10%								
0°	0° - 30°	379	34%	0	119	119	119	116	116	116	111	111	111	6.0	13.8	13.2	0°	55,476
5°	0° - 40°	603	54%	1	106	102	99	104	101	98	100	97	94	8.0	7.7	17.6	45°	43,459
15°	0° - 60°	973	88%	2	94	88	83	92	87	82	89	84	80	10.0	5.0	22.0	55°	35,517
25°	0° - 90°	1,109	100%	3	84	77	71	82	76	70	80	74	69	12.0	3.4	26.4	65°	23,693
35°	90° - 180°	0	0%	4	75	67	61	74	66	61	72	65	60	14.0	2.5	30.9	75°	14,675
45°	0° - 180°	1,109	100%	5	68	60	53	67	59	53	65	58	53				85°	11,885
55°				6	61	53	47	61	53	47	59	52	47	Beam Angle: 95.5°				
65°				7	56	48	42	55	47	42	54	47	42	Field Angle: 142.2°				
75°				8	51	43	38	51	43	38	49	42	38					
85°				9	47	40	34	47	39	34	46	39	34					
90°				10	44	36	31	43	36	31	42	36	31					



Juno Wafer™ LED Downlight Series

4" & 6" SWW5 + ALO LED Flat & Deep Regressed Wafers

PHOTOMETRICS

Distribution Curve

Distribution Data

Output Data

Coefficient of Utilization

Illuminance Data at 30" Above Floor for a Single Luminaire

WF6 ALO20 SWW5 90CRI 27K Input Watts: 15.0, Delivered Lumens: 1209, LPW: 80.6, S/MH: 1.25, Test No: ISF 232965P1

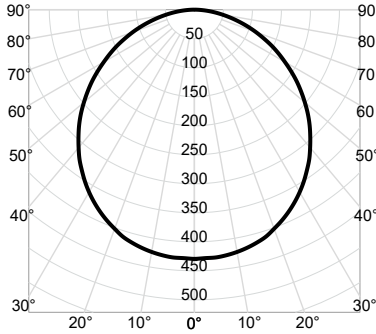

CP Summary	Zonal Lumen Summary				Coefficients of Utilization										Cone of Light			Luminance (cd/sq.m)
	0°	Zone	Lumens	% Fixture	pw	80%		20%		70%		50%		Mounting Height	Initial FC Center Beam	Beam Diameter	Average Luminance	
						50%	30%	10%	50%	30%	10%	50%	30%					10%
	0°	0° - 30°	335	28%	0	119	119	119	116	116	116	111	111	111	6.0	11.9	17.2	0° 35,591
	5°	0° - 40°	547	45%	1	104	100	96	102	98	94	97	94	91	8.0	6.7	22.9	45° 32,906
	15°	0° - 60°	955	79%	2	91	84	78	89	82	77	85	80	75	10.0	4.3	28.6	55° 31,092
	25°	0° - 90°	1,209	100%	3	79	71	65	78	70	64	75	68	63	12.0	3.0	34.4	65° 28,796
	35°	90° - 180°	0	0%	4	70	62	55	69	61	55	67	59	54	14.0	2.2	40.1	75° 25,433
	45°	0° - 180°	1,209	100%	5	63	54	47	62	53	47	60	52	47				85° 21,077
	55°		215		6	57	48	41	56	47	41	54	46	41				
	65°		147		7	51	43	36	51	42	36	49	42	36				
	75°		79		8	47	38	33	46	38	32	45	38	32				
	85°		22		9	43	35	29	43	35	29	41	34	29				
	90°		1		10	40	32	27	39	32	27	38	31	26				

Beam Angle: 110.1°
Field Angle: 162.2°

WF6 ALO20 SWW5 90CRI 30K Input Watts: 15.0, Delivered Lumens: 1239, LPW: 82.6, S/MH: 1.25, Test No: ISF 232965P2

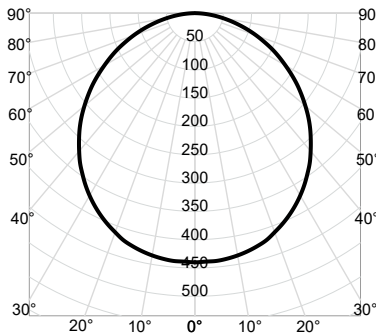

CP Summary	Zonal Lumen Summary				Coefficients of Utilization										Cone of Light			Luminance (cd/sq.m)
	0°	Zone	Lumens	% Fixture	pw	80%		20%		70%		50%		Mounting Height	Initial FC Center Beam	Beam Diameter	Average Luminance	
						50%	30%	10%	50%	30%	10%	50%	30%					10%
	0°	0° - 30°	344	28%	0	119	119	119	116	116	116	111	111	111	6.0	12.2	17.2	0° 36,474
	5°	0° - 40°	560	45%	1	104	100	96	102	98	94	97	94	91	8.0	6.9	22.9	45° 33,723
	15°	0° - 60°	978	79%	2	91	84	78	89	82	77	85	80	75	10.0	4.4	28.6	55° 31,864
	25°	0° - 90°	1,239	100%	3	79	71	65	78	70	64	75	68	63	12.0	3.1	34.4	65° 29,511
	35°	90° - 180°	0	0%	4	70	62	55	69	61	55	67	59	54	14.0	2.2	40.1	75° 26,064
	45°	0° - 180°	1,239	100%	5	63	54	47	62	53	47	60	52	47				85° 21,600
	55°		221		6	57	48	41	56	47	41	54	46	41				
	65°		150		7	51	43	36	51	42	36	49	42	36				
	75°		81		8	47	38	33	46	38	32	45	38	32				
	85°		23		9	43	35	29	43	35	29	41	34	29				
	90°		1		10	40	32	27	39	32	27	38	31	26				

Beam Angle: 110.1°
Field Angle: 162.2°

WF6 ALO20 SWW5 90CRI 35K Input Watts: 15.0, Delivered Lumens: 1299, LPW: 86.6, S/MH: 1.25, Test No: ISF 232965P3

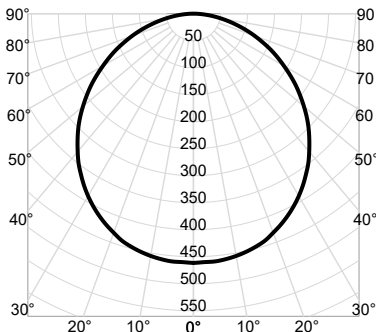

CP Summary	Zonal Lumen Summary				Coefficients of Utilization										Cone of Light			Luminance (cd/sq.m)
	0°	Zone	Lumens	% Fixture	pw	80%		20%		70%		50%		Mounting Height	Initial FC Center Beam	Beam Diameter	Average Luminance	
						50%	30%	10%	50%	30%	10%	50%	30%					10%
	0°	0° - 30°	360	28%	0	119	119	119	116	116	116	111	111	111	6.0	12.8	17.2	0° 38,241
	5°	0° - 40°	587	45%	1	104	100	96	102	98	94	97	94	91	8.0	7.2	22.9	45° 35,356
	15°	0° - 60°	1,026	79%	2	91	84	78	89	82	77	85	80	75	10.0	4.6	28.6	55° 33,407
	25°	0° - 90°	1,299	100%	3	79	71	65	78	70	64	75	68	63	12.0	3.2	34.4	65° 30,940
	35°	90° - 180°	0	0%	4	70	62	55	69	61	55	67	59	54	14.0	2.4	40.1	75° 27,326
	45°	0° - 180°	1,299	100%	5	63	54	47	62	53	47	60	52	47				85° 22,646
	55°		231		6	57	48	41	56	47	41	54	46	41				
	65°		158		7	51	43	36	51	42	36	49	42	36				
	75°		85		8	47	38	33	46	38	32	45	38	32				
	85°		24		9	43	35	29	43	35	29	41	34	29				
	90°		1		10	40	32	27	39	32	27	38	31	26				

Beam Angle: 110.1°
Field Angle: 162.2°



Juno Wafer™ LED Downlight Series

4" & 6" SWW5 + ALO LED Flat & Deep Regressed Wafers

PHOTOMETRICS

Distribution Curve

Distribution Data

Output Data

Coefficient of Utilization

Illuminance Data at 30" Above Floor for a Single Luminaire

WF6 ALO20 SWW5 90CRI 40K Input Watts: 15.0, Delivered Lumens: 1306, LPW: 87.1, S/MH: 1.25, Test No: ISF 232965P4

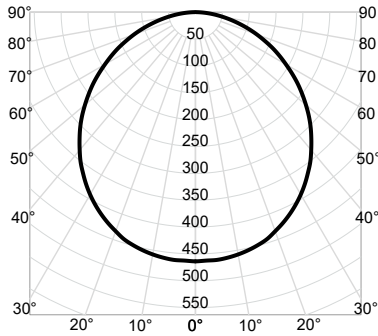

CP Summary				Zonal Lumen Summary				Coefficients of Utilization								Cone of Light			Luminance (cd/sq.m)	
0°	Zone	Lumens	% Fixture	pf	pc	80%		20%		70%		50%		Mounting Height	Initial FC Center Beam	Beam Diameter	Average Luminance			
						pw	50%	30%	10%	50%	30%	10%	50%					30%	10%	
0°	464	0° - 30°	362	28%	0	119	119	119	116	116	116	111	111	111	6.0	12.9	17.2	0°	38,447	
5°	463	0° - 40°	591	45%	1	104	100	96	102	98	94	97	94	91	8.0	7.2	22.9	45°	35,546	
15°	449	0° - 60°	1,031	79%	2	91	84	78	89	82	77	85	80	75	10.0	4.6	28.6	55°	33,587	
25°	415	0° - 90°	1,306	100%	3	79	71	65	78	70	64	75	68	63	12.0	3.2	34.4	65°	31,107	
35°	365	90° - 180°	0	0%	4	70	62	55	69	61	55	67	59	54	14.0	2.4	40.1	75°	27,473	
45°	303	0° - 180°	1,306	100%	5	63	54	47	62	53	47	60	52	47				85°	22,768	
55°	232				6	57	48	41	56	47	41	54	46	41						
65°	159				7	51	43	36	51	42	36	49	42	36						
75°	86				8	47	38	33	46	38	32	45	38	32						
85°	24				9	43	35	29	43	35	29	41	34	29						
90°	1				10	40	32	27	39	32	27	38	31	26						

Beam Angle: 110.1°
Field Angle: 162.2°

WF6 ALO20 SWW5 90CRI 50K Input Watts: 15.0, Delivered Lumens: 1289, LPW: 85.9, S/MH: 1.25, Test No: ISF 232965P5

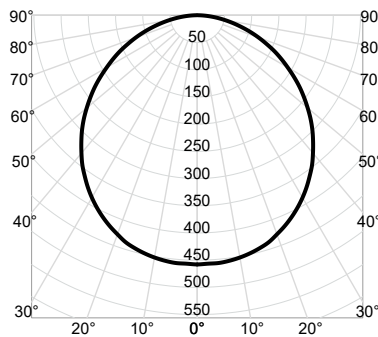

CP Summary				Zonal Lumen Summary				Coefficients of Utilization								Cone of Light			Luminance (cd/sq.m)	
0°	Zone	Lumens	% Fixture	pf	pc	80%		20%		70%		50%		Mounting Height	Initial FC Center Beam	Beam Diameter	Average Luminance			
						pw	50%	30%	10%	50%	30%	10%	50%					30%	10%	
0°	458	0° - 30°	358	28%	0	119	119	119	116	116	116	111	111	111	6.0	12.7	17.2	0°	37,946	
5°	457	0° - 40°	583	45%	1	104	100	96	102	98	94	97	94	91	8.0	7.2	22.9	45°	35,084	
15°	443	0° - 60°	1,018	79%	2	91	84	78	89	82	77	85	80	75	10.0	4.6	28.6	55°	33,150	
25°	410	0° - 90°	1,289	100%	3	79	71	65	78	70	64	75	68	63	12.0	3.2	34.4	65°	30,702	
35°	360	90° - 180°	0	0%	4	70	62	55	69	61	55	67	59	54	14.0	2.3	40.1	75°	27,116	
45°	299	0° - 180°	1,289	100%	5	63	54	47	62	53	47	60	52	47				85°	22,471	
55°	229				6	57	48	41	56	47	41	54	46	41						
65°	157				7	51	43	36	51	42	36	49	42	36						
75°	85				8	47	38	33	46	38	32	45	38	32						
85°	24				9	43	35	29	43	35	29	41	34	29						
90°	1				10	40	32	27	39	32	27	38	31	26						

Beam Angle: 110.1°
Field Angle: 162.2°

WF6 DREG B ALO20 SWW5 90CRI 27K Input Watts: 15.5, Delivered Lumens: 1297, LPW: 83.7, S/MH: 1.21, Test No: ISF 233012P6

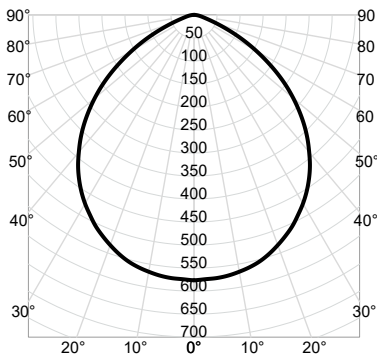

CP Summary				Zonal Lumen Summary				Coefficients of Utilization								Cone of Light			Luminance (cd/sq.m)	
0°	Zone	Lumens	% Fixture	pf	pc	80%		20%		70%		50%		Mounting Height	Initial FC Center Beam	Beam Diameter	Average Luminance			
						pw	50%	30%	10%	50%	30%	10%	50%					30%	10%	
0°	577	0° - 30°	444	34%	0	119	119	119	116	116	116	111	111	111	6.0	16.0	14.0	0°	35,770	
5°	574	0° - 40°	715	55%	1	107	103	100	105	101	99	100	98	95	8.0	9.0	18.7	45°	29,701	
15°	554	0° - 60°	1,170	90%	2	95	89	84	93	88	83	90	85	82	10.0	5.8	23.3	55°	23,790	
25°	506	0° - 90°	1,297	100%	3	85	78	72	83	77	71	80	75	70	12.0	4.0	28.0	65°	13,951	
35°	435	90° - 180°	0	0%	4	76	68	62	75	67	62	72	66	61	14.0	2.9	32.7	75°	5,207	
45°	339	0° - 180°	1,297	100%	5	69	60	54	67	60	54	65	59	54				85°	3,221	
55°	220				6	62	54	48	61	53	48	59	53	47						
65°	95				7	57	48	43	56	48	43	54	47	42						
75°	22				8	52	44	38	51	44	38	50	43	38						
85°	5				9	48	40	35	47	40	35	46	39	34						
90°	0				10	44	37	32	44	36	32	43	36	31						

Beam Angle: 98.8°
Field Angle: 137.4°



Juno Wafer™ LED Downlight Series

4" & 6" SWW5 + ALO LED Flat & Deep Regressed Wafers

PHOTOMETRICS

Distribution Curve

Distribution Data

Output Data

Coefficient of Utilization

Illuminance Data at 30" Above Floor for a Single Luminaire

WF6 DREG B ALO20 SWW5 90CRI 30K Input Watts: 15.5, Delivered Lumens: 1409, LPW: 90.9, S/MH: 1.21, Test No: ISF 233012P7

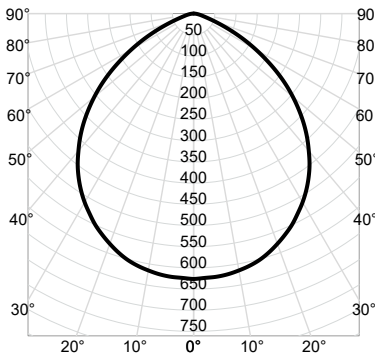

CP Summary		Zonal Lumen Summary		Coefficients of Utilization						Cone of Light			Luminance (cd/sq.m)					
0°	Zone	Lumens	% Fixture	pf	pc	80%		20%		50%	Mounting Height	Initial FC Center Beam	Beam Diameter	Average Luminance				
						50%	30%	10%	50%						30%	10%		
0°	0° - 30°	482	34%	0	119	119	119	116	116	111	111	111	6.0	17.4	14.0	0°	38,859	
5°	0° - 40°	777	55%	1	107	103	100	105	101	99	100	98	95	8.0	9.8	18.7	45°	32,265
15°	0° - 60°	1,271	90%	2	95	89	84	93	88	83	90	85	82	10.0	6.3	23.3	55°	25,844
25°	0° - 90°	1,409	100%	3	85	78	72	83	77	71	80	75	70	12.0	4.3	28.0	65°	15,156
35°	90° - 180°	0	0%	4	76	68	62	75	67	62	72	66	61	14.0	3.2	32.7	75°	5,657
45°	0° - 180°	1,409	100%	5	69	60	54	67	60	54	65	59	54				85°	3,500
55°		239		6	62	54	48	61	53	48	59	53	47	Beam Angle: 98.8°				
65°		103		7	57	48	43	56	48	43	54	47	42	Field Angle: 137.4°				
75°		24		8	52	44	38	51	44	38	50	43	38					
85°		5		9	48	40	35	47	40	35	46	39	34					
90°		0		10	44	37	32	44	36	32	43	36	31					

WF6 DREG B ALO20 SWW5 90CRI 35K Input Watts: 15.5, Delivered Lumens: 1489, LPW: 96.1, S/MH: 1.21, Test No: ISF 233012P8

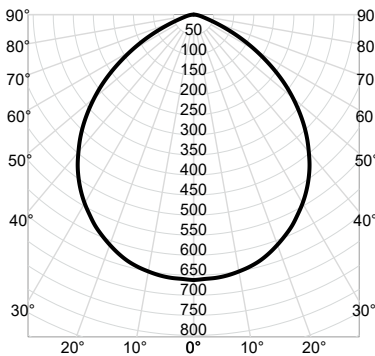

CP Summary		Zonal Lumen Summary		Coefficients of Utilization						Cone of Light			Luminance (cd/sq.m)					
0°	Zone	Lumens	% Fixture	pf	pc	80%		20%		50%	Mounting Height	Initial FC Center Beam	Beam Diameter	Average Luminance				
						50%	30%	10%	50%						30%	10%		
0°	0° - 30°	509	34%	0	119	119	119	116	116	111	111	111	6.0	18.4	14.0	0°	41,065	
5°	0° - 40°	821	55%	1	107	103	100	105	101	99	100	98	95	8.0	10.3	18.7	45°	34,097
15°	0° - 60°	1,343	90%	2	95	89	84	93	88	83	90	85	82	10.0	6.6	23.3	55°	27,312
25°	0° - 90°	1,489	100%	3	85	78	72	83	77	71	80	75	70	12.0	4.6	28.0	65°	16,017
35°	90° - 180°	0	0%	4	76	68	62	75	67	62	72	66	61	14.0	3.4	32.7	75°	5,978
45°	0° - 180°	1,489	100%	5	69	60	54	67	60	54	65	59	54				85°	3,698
55°		252		6	62	54	48	61	53	48	59	53	47	Beam Angle: 98.8°				
65°		109		7	57	48	43	56	48	43	54	47	42	Field Angle: 137.4°				
75°		25		8	52	44	38	51	44	38	50	43	38					
85°		5		9	48	40	35	47	40	35	46	39	34					
90°		0		10	44	37	32	44	36	32	43	36	31					

WF6 DREG B ALO20 SWW5 90CRI 40K Input Watts: 15.5, Delivered Lumens: 1500, LPW: 96.8, S/MH: 1.21, Test No: ISF 233012P9

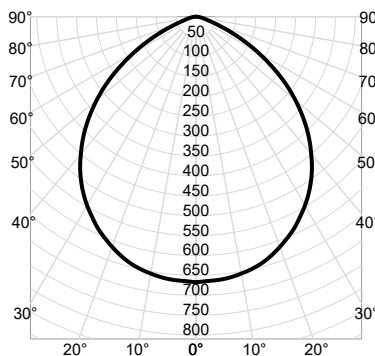

CP Summary		Zonal Lumen Summary		Coefficients of Utilization						Cone of Light			Luminance (cd/sq.m)					
0°	Zone	Lumens	% Fixture	pf	pc	80%		20%		50%	Mounting Height	Initial FC Center Beam	Beam Diameter	Average Luminance				
						50%	30%	10%	50%						30%	10%		
0°	0° - 30°	513	34%	0	119	119	119	116	116	111	111	111	6.0	18.5	14.0	0°	41,368	
5°	0° - 40°	827	55%	1	107	103	100	105	101	99	100	98	95	8.0	10.4	18.7	45°	34,349
15°	0° - 60°	1,353	90%	2	95	89	84	93	88	83	90	85	82	10.0	6.7	23.3	55°	27,513
25°	0° - 90°	1,500	100%	3	85	78	72	83	77	71	80	75	70	12.0	4.6	28.0	65°	16,135
35°	90° - 180°	0	0%	4	76	68	62	75	67	62	72	66	61	14.0	3.4	32.7	75°	6,022
45°	0° - 180°	1,500	100%	5	69	60	54	67	60	54	65	59	54				85°	3,726
55°		254		6	62	54	48	61	53	48	59	53	47	Beam Angle: 98.8°				
65°		110		7	57	48	43	56	48	43	54	47	42	Field Angle: 137.4°				
75°		25		8	52	44	38	51	44	38	50	43	38					
85°		5		9	48	40	35	47	40	35	46	39	34					
90°		0		10	44	37	32	44	36	32	43	36	31					



Juno Wafer™ LED Downlight Series

4" & 6" SWW5 + ALO LED Flat & Deep Regressed Wafers

PHOTOMETRICS

Distribution Curve

Distribution Data

Output Data

Coefficient of Utilization

Illuminance Data at 30" Above Floor for a Single Luminaire

WF6 DREG B ALO20 SWW5 90CRI 50K Input Watts: 15.5, Delivered Lumens: 1412, LPW: 91.1, S/MH: 1.21, Test No: ISF 233012P10

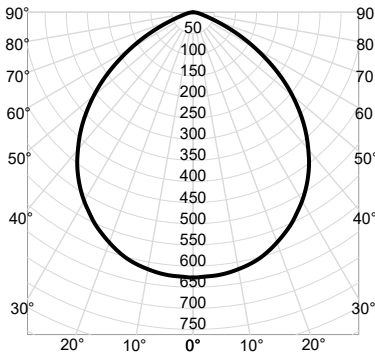

CP Summary		Zonal Lumen Summary		Coefficients of Utilization						Cone of Light			Luminance (cd/sq.m)			
0°	Zone	Lumens	% Fixture	pf pc	80%		20%		50%		Mounting Height	Initial FC Center Beam	Beam Diameter	Average Luminance		
					50%	30%	10%	50%	30%	10%						
0°	0° - 30°	483	34%	0	119	119	119	116	116	116	111	111	111	111	0°	38,941
5°	0° - 40°	778	55%	1	107	103	100	105	101	99	100	98	95	95	45°	32,334
15°	0° - 60°	1,274	90%	2	95	89	84	93	88	83	90	85	82	82	55°	25,899
25°	0° - 90°	1,412	100%	3	85	78	72	83	77	71	80	75	70	70	65°	15,188
35°	90° - 180°	0	0%	4	76	68	62	75	67	62	72	66	61	61	75°	5,669
45°	0° - 180°	1,412	100%	5	69	60	54	67	60	54	65	59	54	54	85°	3,507
55°		239		6	62	54	48	61	53	48	59	53	47	47		
65°		103		7	57	48	43	56	48	43	54	47	42	42		
75°		24		8	52	44	38	51	44	38	50	43	38	38		
85°		5		9	48	40	35	47	40	35	46	39	34	34		
90°		0		10	44	37	32	44	36	32	43	36	31	31		

WF6 DREG SM ALO20 SWW5 90CRI 27K Input Watts: 15.5, Delivered Lumens: 1297, LPW: 83.7, S/MH: 1.21, Test No: ISF 233012P1

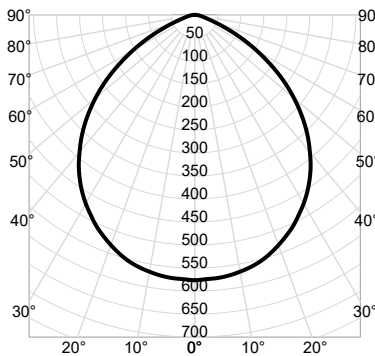

CP Summary		Zonal Lumen Summary		Coefficients of Utilization						Cone of Light			Luminance (cd/sq.m)			
0°	Zone	Lumens	% Fixture	pf pc	80%		20%		50%		Mounting Height	Initial FC Center Beam	Beam Diameter	Average Luminance		
					50%	30%	10%	50%	30%	10%						
0°	0° - 30°	444	34%	0	119	119	119	116	116	116	111	111	111	111	0°	35,770
5°	0° - 40°	715	55%	1	107	103	100	105	101	99	100	98	95	95	45°	29,701
15°	0° - 60°	1,170	90%	2	95	89	84	93	88	83	90	85	82	82	55°	23,790
25°	0° - 90°	1,297	100%	3	85	78	72	83	77	71	80	75	70	70	65°	13,951
35°	90° - 180°	0	0%	4	76	68	62	75	67	62	72	66	61	61	75°	5,207
45°	0° - 180°	1,297	100%	5	69	60	54	67	60	54	65	59	54	54	85°	3,221
55°		220		6	62	54	48	61	53	48	59	53	47	47		
65°		95		7	57	48	43	56	48	43	54	47	42	42		
75°		22		8	52	44	38	51	44	38	50	43	38	38		
85°		5		9	48	40	35	47	40	35	46	39	34	34		
90°		0		10	44	37	32	44	36	32	43	36	31	31		

WF6 DREG SM ALO20 SWW5 90CRI 30K Input Watts: 15.5, Delivered Lumens: 1409, LPW: 90.9, S/MH: 1.21, Test No: ISF 233012P2

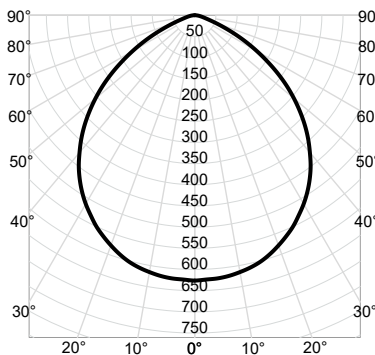

CP Summary		Zonal Lumen Summary		Coefficients of Utilization						Cone of Light			Luminance (cd/sq.m)			
0°	Zone	Lumens	% Fixture	pf pc	80%		20%		50%		Mounting Height	Initial FC Center Beam	Beam Diameter	Average Luminance		
					50%	30%	10%	50%	30%	10%						
0°	0° - 30°	482	34%	0	119	119	119	116	116	116	111	111	111	111	0°	38,859
5°	0° - 40°	777	55%	1	107	103	100	105	101	99	100	98	95	95	45°	32,265
15°	0° - 60°	1,271	90%	2	95	89	84	93	88	83	90	85	82	82	55°	25,844
25°	0° - 90°	1,409	100%	3	85	78	72	83	77	71	80	75	70	70	65°	15,156
35°	90° - 180°	0	0%	4	76	68	62	75	67	62	72	66	61	61	75°	5,657
45°	0° - 180°	1,409	100%	5	69	60	54	67	60	54	65	59	54	54	85°	3,500
55°		239		6	62	54	48	61	53	48	59	53	47	47		
65°		103		7	57	48	43	56	48	43	54	47	42	42		
75°		24		8	52	44	38	51	44	38	50	43	38	38		
85°		5		9	48	40	35	47	40	35	46	39	34	34		
90°		0		10	44	37	32	44	36	32	43	36	31	31		



Juno Wafer™ LED Downlight Series

4" & 6" SWW5 + ALO LED Flat & Deep Regressed Wafers

PHOTOMETRICS

Distribution Curve

Distribution Data

Output Data

Coefficient of Utilization

Illuminance Data at 30" Above Floor for a Single Luminaire

WF6 DREG SM ALO20 SWW5 90CRI 35K Input Watts: 15.5, Delivered Lumens: 1489, LPW: 96.1, S/MH: 1.21, Test No: ISF 233012P3

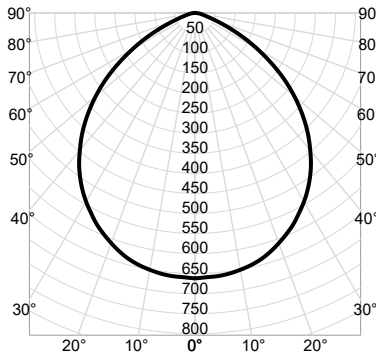

0°	CP Summary		Zonal Lumen Summary		Coefficients of Utilization									Cone of Light			Luminance (cd/sq.m)	
	Zone	Lumens % Fixture	pf		pc	80%			20%			50%			Mounting Height	Initial FC Center Beam	Beam Diameter	Average Luminance
			50%	30%	10%	50%	30%	10%	50%	30%	10%							
0°	662	0° - 30° 509 34%	0	119	119	119	116	116	116	111	111	111	6.0	18.4	14.0	0°	41,065	
5°	659	0° - 40° 821 55%	1	107	103	100	105	101	99	100	98	95	8.0	10.3	18.7	45°	34,097	
15°	636	0° - 60° 1,343 90%	2	95	89	84	93	88	83	90	85	82	10.0	6.6	23.3	55°	27,312	
25°	581	0° - 90° 1,489 100%	3	85	78	72	83	77	71	80	75	70	12.0	4.6	28.0	65°	16,017	
35°	500	90° - 180° 0 0%	4	76	68	62	75	67	62	72	66	61	14.0	3.4	32.7	75°	5,978	
45°	389	0° - 180° 1,489 100%	5	69	60	54	67	60	54	65	59	54	Beam Angle: 98.8°			85°	3,698	
55°	252		6	62	54	48	61	53	48	59	53	47	Field Angle: 137.4°					
65°	109		7	57	48	43	56	48	43	54	47	42						
75°	25		8	52	44	38	51	44	38	50	43	38						
85°	5		9	48	40	35	47	40	35	46	39	34						
90°	0		10	44	37	32	44	36	32	43	36	31						

WF6 DREG SM ALO20 SWW5 90CRI 40K Input Watts: 15.5, Delivered Lumens: 1500, LPW: 96.8, S/MH: 1.21, Test No: ISF 233012P4

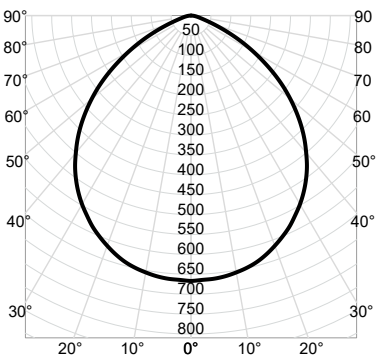

0°	CP Summary		Zonal Lumen Summary		Coefficients of Utilization									Cone of Light			Luminance (cd/sq.m)	
	Zone	Lumens % Fixture	pf		pc	80%			20%			50%			Mounting Height	Initial FC Center Beam	Beam Diameter	Average Luminance
			50%	30%	10%	50%	30%	10%	50%	30%	10%							
0°	667	0° - 30° 513 34%	0	119	119	119	116	116	116	111	111	111	6.0	18.5	14.0	0°	41,368	
5°	664	0° - 40° 827 55%	1	107	103	100	105	101	99	100	98	95	8.0	10.4	18.7	45°	34,349	
15°	641	0° - 60° 1,353 90%	2	95	89	84	93	88	83	90	85	82	10.0	6.7	23.3	55°	27,513	
25°	585	0° - 90° 1,500 100%	3	85	78	72	83	77	71	80	75	70	12.0	4.6	28.0	65°	16,135	
35°	503	90° - 180° 0 0%	4	76	68	62	75	67	62	72	66	61	14.0	3.4	32.7	75°	6,022	
45°	391	0° - 180° 1,500 100%	5	69	60	54	67	60	54	65	59	54	Beam Angle: 98.8°			85°	3,726	
55°	254		6	62	54	48	61	53	48	59	53	47	Field Angle: 137.4°					
65°	110		7	57	48	43	56	48	43	54	47	42						
75°	25		8	52	44	38	51	44	38	50	43	38						
85°	5		9	48	40	35	47	40	35	46	39	34						
90°	0		10	44	37	32	44	36	32	43	36	31						

WF6 DREG SM ALO20 SWW5 90CRI 50K Input Watts: 15.5, Delivered Lumens: 1412, LPW: 91.1, S/MH: 1.21, Test No: ISF 233012P5

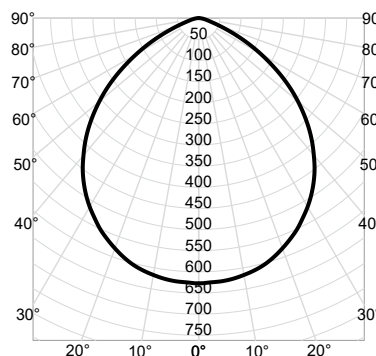

0°	CP Summary		Zonal Lumen Summary		Coefficients of Utilization									Cone of Light			Luminance (cd/sq.m)	
	Zone	Lumens % Fixture	pf		pc	80%			20%			50%			Mounting Height	Initial FC Center Beam	Beam Diameter	Average Luminance
			50%	30%	10%	50%	30%	10%	50%	30%	10%							
0°	628	0° - 30° 483 34%	0	119	119	119	116	116	116	111	111	111	6.0	17.4	14.0	0°	38,941	
5°	625	0° - 40° 778 55%	1	107	103	100	105	101	99	100	98	95	8.0	9.8	18.7	45°	32,334	
15°	603	0° - 60° 1,274 90%	2	95	89	84	93	88	83	90	85	82	10.0	6.3	23.3	55°	25,899	
25°	551	0° - 90° 1,412 100%	3	85	78	72	83	77	71	80	75	70	12.0	4.4	28.0	65°	15,188	
35°	474	90° - 180° 0 0%	4	76	68	62	75	67	62	72	66	61	14.0	3.2	32.7	75°	5,669	
45°	369	0° - 180° 1,412 100%	5	69	60	54	67	60	54	65	59	54	Beam Angle: 98.8°			85°	3,507	
55°	239		6	62	54	48	61	53	48	59	53	47	Field Angle: 137.4°					
65°	103		7	57	48	43	56	48	43	54	47	42						
75°	24		8	52	44	38	51	44	38	50	43	38						
85°	5		9	48	40	35	47	40	35	46	39	34						
90°	0		10	44	37	32	44	36	32	43	36	31						



Juno Wafer™ LED Downlight Series

4" & 6" SWW5 + ALO LED Flat & Deep Regressed Wafers

Project:
Fixture Type:
Location:
Contact/Phone:

WF4 & WF6 SWW5 + ALO Series

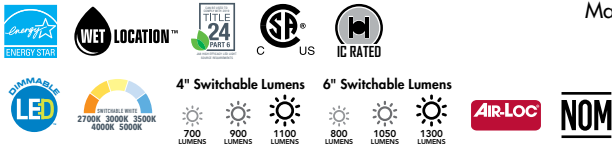
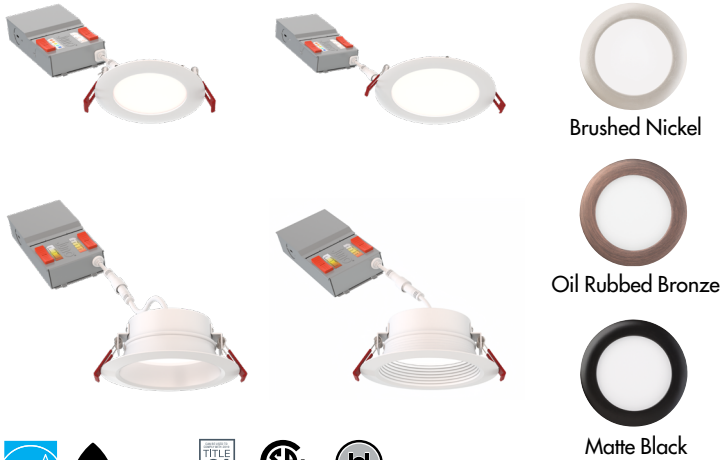

Product Features

The 4" & 6" flat and deep regressed with 5CCT Switchable White and ALO technology wafers provide high-quality light output and efficiency while delivering industry leading technology and functionality without the need for a recessed housing.

- Next-generation optical technology and design enable precise, even illumination where needed
- Canless - no can required; equals easy to install and less labor
- With selectable color temperatures ranging from warm (2700K) to daylight (5000K), getting the right look for your space is a breeze
- 3 ALO settings allow you to get the perfect amount of light in your space

Applications

- Residential and light commercial applications including multi-family, hospitality, assisted living, dormitories and other multi-level construction
- Streamlined profile allows for easy remodel or new construction in both insulated and drop ceiling installations
- Wet rated and airtight: perfect for showers, bathrooms, and covered outdoor soffits

Dimensions

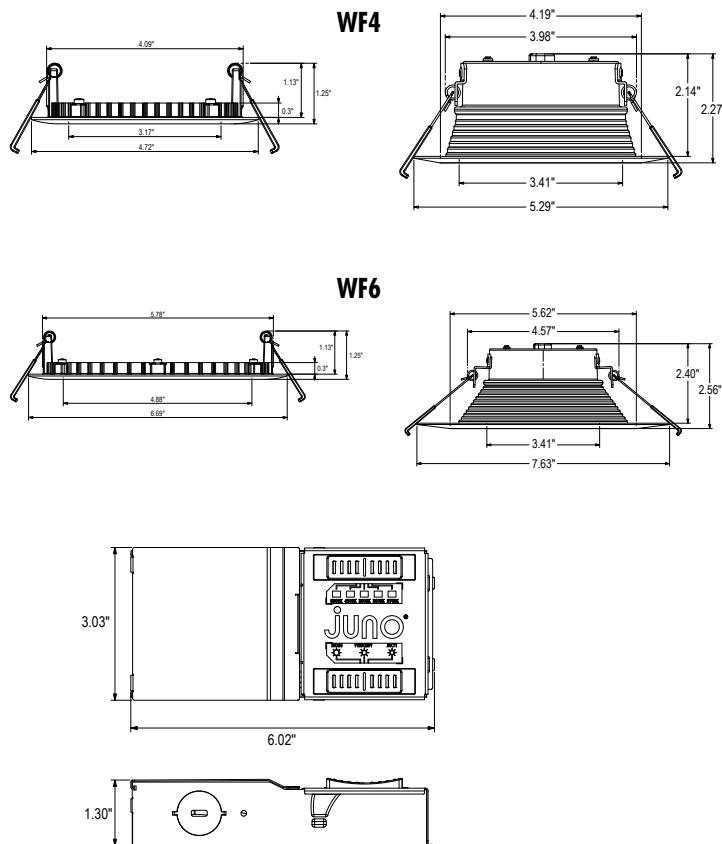

Performance

Delivered Lumens	4" - 700/900/1100 6" - 800/1050/1300
LED Color Temperature	Switchable White (27K, 30K, 35K, 40K, 50K) Default set at 3000K
CRI	90+
Voltage	Dedicated 120V and MVOLT
Dimming	Dimmable to 10% with triac or 0-10v dimmers

For a list of compatible dimmers see [JUNO-WAFERS-DIM](#)

Specifications

	FLAT		DREG	
	WF4	WF6	WF4	WF6
Aperture:	3.17"	4.88"	3.41"	3.41"
Ceiling Opening:	4.25"	6.25"	4.25"	6.25"
Overlap Trim:	4.72"	6.69"	5.29"	7.63"
Height:	1.25"	1.25"	2.27"	2.56"



Juno Wafer™ LED Downlight Series

4" & 6" SWW5 + ALO LED Flat & Deep Regressed Wafers

ORDERING INFORMATION

Flat Wafer

Example: WF4 ALO19 SWW5 90CRI MW

Series	Trim Designation	Lumens	Color Temperature	Rendering Index	Voltage	Finish
WF4 4" Wafer Led Downlight	(BLANK) Flat	ALO19 ¹ Switchable lumens – 700LM, 1000LM, and 1100LM	SWW5 Switchable CCT – 2700K, 3000K, 3500K, 4000K, and 5000K	90CRI 90+ CRI	(BLANK) 120V MVOLT Multi-Volt (120-277)	MW Matte White MB Matte Black BN Brushed Nickel ORB Oil Rubbed Bronze
WF6 6" Wafer Led Downlight		ALO20 ² Switchable lumens – 800LM, 1050LM, and 1300LM				

Deep Regressed Wafer

Example: WF6 DREG B ALO20 SWW5 90CRI MW

Series	Trim Designation	Trim Style	Lumens	Color Temperature	Rendering Index	Voltage	Finish ³
WF4 4" Wafer Led Downlight	DREG Deep Regressed	B Baffle	ALO19 ¹ Switchable lumens – 700LM, 1000LM, and 1100LM	SWW5 Switchable CCT – 2700K, 3000K, 3500K, 4000K, and 5000K	90CRI 90+ CRI	(BLANK) 120V	MW Matte White
WF6 6" Wafer Led Downlight		SM Smooth	ALO20 ² Switchable lumens – 800LM, 1050LM, and 1300LM				

1. Only available with WF4.
2. Only available with WF6.
3. For additional finishes see [trim insert](#) offerings.

Accessories: Order as separate catalog number.

Series	
WF8643 PAN R6	Universal New Construction Pan, Retail Pack of 6
WF8643 PAN U	Universal New Construction Pan, Unit Pack
WF4 PAN R12	4" New construction pan, retail pack of 12
WF4GR MW JZ	4" Wafer Goof Ring 4.2" ID x 6.2" OD
WF6 PAN R12	6" New construction pan, retail pack of 12
WF6GR MW JZ	6" Wafer Goof Ring 6" ID x 8" OD
WFJB U	Remodel Joist Bar
WFEXC6 SW3PIN FT4	3-Pin 6ft Cable
WFEXC10 SW3PIN FT4	3-Pin 10ft Cable
WFEXC20 SW3PIN FT4	3-Pin 20ft Cable



WF8643 UNIVERSAL New Construction Pan



WF4 PAN 4" New Construction Pan



Remodel Joist Bar



WFEXC_ 3-Pin Extension Cable



WF6 PAN 6" New Construction Pan

*Goof rings are made of 22 gauge steel and painted white.

PERFORMANCE DATA

	WF4 (DREG) ALO19 SWW5			WF6 (DREG) ALO20 SWW5		
	High	Medium	Low	High	Medium	Low
Input Power Typical	14.5W (+/-5%)	11.75(+/-5%)	8.56(+/-5%)	14.5W (+/-5%)	11.75(+/-5%)	8.56(+/-5%)
Input Voltage	120V			120V		
Frequency	60 Hz			60 Hz		
EMI/RFI	FCC Title 47, Part 15 Class B (consumer)			FCC Title 47, Part 15 Class B (consumer)		
Minimum Starting Temp	-40°F (-40°C)			-40°F (-40°C)		

Note: Actual performance may differ as a result of end-user environment and application. All values are design or typical values, measured under laboratory conditions at 25°C.



Juno Wafer™ LED Downlight Series

4" & 6" SWW5 + ALO LED Flat & Deep Regressed Wafers

TRIM INSERTS

TRIM INSERTS (for field configuration; ordered separately)

Example: 4BEMB R4

Series/Finish		Packaging		
4BEMB	4" Baffle, Matte Black	4SEMB	4" Smooth, Matte Black	R4 Retail Pack of 4 units
4BEBN	4" Baffle, Brush Nickel	4SEBN	4" Smooth, Brush Nickel	
4BEORB	4" Baffle, Oil-Rubbed Bronze	4SEORB	4" Smooth, Oil-Rubbed Bronze	



4" Baffle, Matte Black (4BEMB)



4" Baffle, Brush Nickel (4BEBN)



4" Baffle, Oil-Rubbed Bronze (4BEORB)



4" Smooth, Matte Black (4SEMB)



4" Smooth, Brush Nickel (4SEBN)



4" Smooth, Oil-Rubbed Bronze (4SEORB)



Pre-Install color finish trim insert over white 4" or 6" Wafer LED Downlight.



Press down color finish tabs for post-installation to create final Wafer LED Downlight.

TRIM INSERTS

TRIM INSERTS (for field configuration; ordered separately)

Example: 6SSEBN R4

Series/Finish		Packaging		
6SBEMB	6" Baffle, Matte Black	6SSEMB	6" Smooth, Matte Black	R4 Retail Pack of 4 units
6SBEBN	6" Baffle, Matte Nickel	6SSEBN	6" Smooth, Brush Nickel	
6SBEORB	6" Baffle, Oil-Rubbed Bronze	6SSEORB	6" Smooth, Oil-Rubbed Bronze	

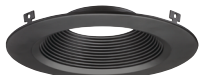

6" Baffle, Matte Black (6SBEMB)

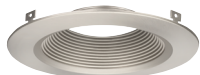

6" Baffle, Brush Nickel (6SBEBN)

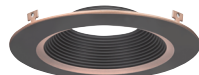

6" Baffle, Oil-Rubbed Bronze (6SBEORB)



6" Smooth, Matte Black (6SSEMB)



6" Smooth, Brush Nickel (6SSEBN)



6" Smooth, Oil-Rubbed Bronze (6SSEORB)



Juno Wafer™ LED Downlight Series

4" & 6" SWW5 + ALO LED Flat & Deep Regressed Wafers

Specifications

Housing

Aluminum die cast outer frame. Durable, powder coat paint to prevent rust

- FT4 3-pin plenum rated cable connector to connect from module to remote driver box
- Steel spring clip for easy installation. 4" or 6" cut out template is provided to ensure a correct sized hole is cut into ceiling for proper installation of the trim. Size of hole should not exceed 4-1/4" for the WF4 and 6-1/4" for the WF6
- Can be installed from 3/8" to 1 1/2" ceiling thickness
- Can be removed from below the ceiling for service or replacement.

LED Light Engine

Low/Medium/High lumen output settings and choice of 2700K, 3000K, 3500K, 4000K or 5000K color temperatures

- 90 CRI minimum
- Color accuracy within 4 step MacAdams Ellipse at the end CCT (2700K and 5000K), within 6 step MacAdams Ellipse in the middle CCT (3000K, 3500K, and 4000K)
- Dimming 100% to 10% with most standard incandescent dimers (see list of approved dimmers).

Driver

Connect directly to 120V Class-2 (CAN ICES-005 (B) / NMB-005 (B)) LED driver

- 120V 60 Hz constant current driver provides noise free operation
- IC rated driver with convenience of a switch to choose between 5 selectable color temperature options ranging from 2700K (warm white), 3000K, 3500K, 4000K, or 5000K (daylight)
- The isolated driver integrated inside steel remote box with four 7/8" knockouts with slots for pryout. Suitable for pulling wires with the 12 cubic-inch wiring compartment to accommodate up to (6) 14 gauge insulated conductor or (4) 12 gauge insulated conductors, making the Wafer LED Downlights much easier to wire in 2in/2out (plus ground) daisy-chain applications and contractor friendly
- 2" plenum space required for the installation of the WF6 driver box; 3" plenum space required for the installation of the WF4 driver box
- Suitable for installation in t-grid and drop ceiling applications with universal new construction pan.

Electrical

Multi-volt (120-277V, 50/60Hz) proprietary remote LED driver/splice box, with two (2) additional low-voltage wires for 0-10v dimming, down to 10% (depending on dimmer model and application). High efficient driver with power factor > 0.9. Ambient operating temperature: -40°F (-40°C) to +104°F (+40°C).

Optical System

Both edge-lit and back-lit technologies are used to distribute light

- Polycarbonate lens provides even illumination throughout the space
- Efficient system that can produce over 1100 lumens while using 14.5W with the WF4 and over 1300 lumens while using 16W with the WF6
- Replaces 65W incandescent (WF4) and 75W incandescent (WF6).

Life

Rated for 50,000 hours at 70% lumen maintenance.

Labels

CSA certified to US and Canadian safety standards

- ENERGY STAR® certified product
- Suitable for wet location, covered ceiling
- Air-Loc certified in accordance with ASTM E283-2004
- NOM Certified
- Can be used to comply with California Title 24 Part 6 High Efficacy LED light Source Requirements
- U.S. Patent No. 10,681,784.

Testing

All reports are based on published industry procedures; field performance may differ from laboratory performance.

Warranty

3-year limited warranty. This is the only warranty provided and no other statements in this specification sheet create any warranty of any kind. All other express and implied warranties are disclaimed. Complete warranty terms located at: www.acuitybrands.com/support/warranty/terms-and-conditions

Note: Actual performance may differ as a result of end-user environment and application.

All values are design or typical values, measured under laboratory conditions at 25 °C.

Specifications subject to change without notice.



Juno Wafer™ LED Downlight Series

4" & 6" SWW5 + ALO LED Flat & Deep Regressed Wafers

PHOTOMETRICS

Distribution Curve

Distribution Data

Output Data

Coefficient of Utilization

Illuminance Data at 30" Above Floor for a Single Luminaire

Lumen Multiplier			
	LOW	MEDIUM	HIGH
120V	0.65	0.85	1.00
MVOLT	0.58	0.84	1.00

WF4 ALO19 SWW5 90CRI 27K-HI Input Watts: 13.5, Delivered Lumens: 980, LPW: 72.6, S/MH: 1.27, Test No: ISF 232959P1

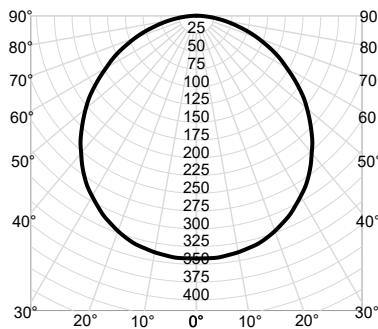

CP Summary		Zonal Lumen Summary		Coefficients of Utilization						Cone of Light			Luminance (cd/sq.m)					
0°	Zone	Lumens	% Fixture	pf	80%		20%		50%		Mounting Height	Initial FC Center Beam	Beam Diameter	Average Luminance				
				pc	50%	30%	10%	50%	30%	10%								
0°	342	0° - 30°	269	27%	0	119	119	119	116	116	111	111	111	6.0	9.5	17.7	0°	79,127
5°	342	0° - 40°	441	45%	1	104	100	96	102	98	94	97	94	8.0	5.3	23.6	45°	74,900
15°	333	0° - 60°	774	79%	2	91	84	78	89	82	77	85	80	10.0	3.4	29.5	55°	71,000
25°	310	0° - 90°	980	100%	3	79	71	65	78	70	64	75	68	12.0	2.4	35.4	65°	65,905
35°	275	90° - 180°	0	0%	4	70	62	55	69	61	54	67	59	14.0	1.7	41.3	75°	57,068
45°	229	0° - 180°	980	100%	5	63	54	47	62	53	47	60	52	46			85°	43,578
55°	176				6	57	48	41	56	47	41	54	46	41				
65°	120				7	51	43	36	51	42	36	49	41	36				
75°	64				8	47	38	32	46	38	32	45	37	32				
85°	16				9	43	35	29	42	34	29	41	34	29				
90°	0				10	40	32	26	39	32	26	38	31	26				

WF4 ALO19 SWW5 90CRI 30K-HI Input Watts: 13.5, Delivered Lumens: 1048, LPW: 77.6, S/MH: 1.27, Test No: ISF 232959P2

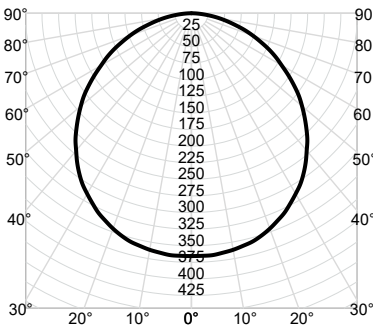

CP Summary		Zonal Lumen Summary		Coefficients of Utilization						Cone of Light			Luminance (cd/sq.m)					
0°	Zone	Lumens	% Fixture	pf	80%		20%		50%		Mounting Height	Initial FC Center Beam	Beam Diameter	Average Luminance				
				pc	50%	30%	10%	50%	30%	10%								
0°	366	0° - 30°	288	27%	0	119	119	119	116	116	111	111	111	6.0	10.2	17.7	0°	84,618
5°	366	0° - 40°	472	45%	1	104	100	96	102	98	94	97	94	8.0	5.7	23.6	45°	80,097
15°	356	0° - 60°	828	79%	2	91	84	78	89	82	77	85	80	10.0	3.7	29.5	55°	75,927
25°	331	0° - 90°	1,048	100%	3	79	71	65	78	70	64	75	68	12.0	2.5	35.4	65°	70,478
35°	294	90° - 180°	0	0%	4	70	62	55	69	61	54	67	59	14.0	1.9	41.3	75°	61,028
45°	245	0° - 180°	1,048	100%	5	63	54	47	62	53	47	60	52	46			85°	46,602
55°	188				6	57	48	41	56	47	41	54	46	41				
65°	129				7	51	43	36	51	42	36	49	41	36				
75°	68				8	47	38	32	46	38	32	45	37	32				
85°	18				9	43	35	29	42	34	29	41	34	29				
90°	0				10	40	32	26	39	32	26	38	31	26				

WF4 ALO19 SWW5 90CRI 35K-HI Input Watts: 13.5, Delivered Lumens: 1107, LPW: 82.0, S/MH: 1.27, Test No: ISF 232959P3

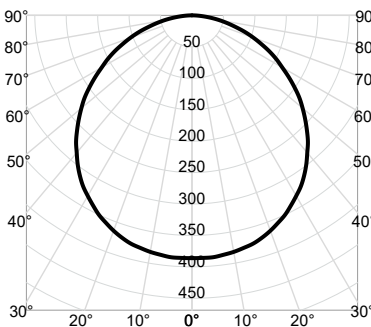

CP Summary		Zonal Lumen Summary		Coefficients of Utilization						Cone of Light			Luminance (cd/sq.m)					
0°	Zone	Lumens	% Fixture	pf	80%		20%		50%		Mounting Height	Initial FC Center Beam	Beam Diameter	Average Luminance				
				pc	50%	30%	10%	50%	30%	10%								
0°	386	0° - 30°	304	27%	0	119	119	119	116	116	111	111	111	6.0	10.7	17.7	0°	89,381
5°	386	0° - 40°	498	45%	1	104	100	96	102	98	94	97	94	8.0	6.0	23.6	45°	84,607
15°	376	0° - 60°	875	79%	2	91	84	78	89	82	77	85	80	10.0	3.9	29.5	55°	80,201
25°	350	0° - 90°	1,107	100%	3	79	71	65	78	70	64	75	68	12.0	2.7	35.4	65°	74,446
35°	311	90° - 180°	0	0%	4	70	62	55	69	61	54	67	59	14.0	2.0	41.3	75°	64,464
45°	258	0° - 180°	1,107	100%	5	63	54	47	62	53	47	60	52	46			85°	49,226
55°	199				6	57	48	41	56	47	41	54	46	41				
65°	136				7	51	43	36	51	42	36	49	41	36				
75°	72				8	47	38	32	46	38	32	45	37	32				
85°	19				9	43	35	29	42	34	29	41	34	29				
90°	0				10	40	32	26	39	32	26	38	31	26				



Juno Wafer™ LED Downlight Series

4" & 6" SWW5 + ALO LED Flat & Deep Regressed Wafers

PHOTOMETRICS

Distribution Curve

Distribution Data

Output Data

Coefficient of Utilization

Illuminance Data at 30" Above Floor for a Single Luminaire

WF4 ALO19 SWW5 90CRI 40K-HI Input Watts: 13.5, Delivered Lumens: 1124, LPW: 83.3, S/MH: 1.27, Test No: ISF 232959P4

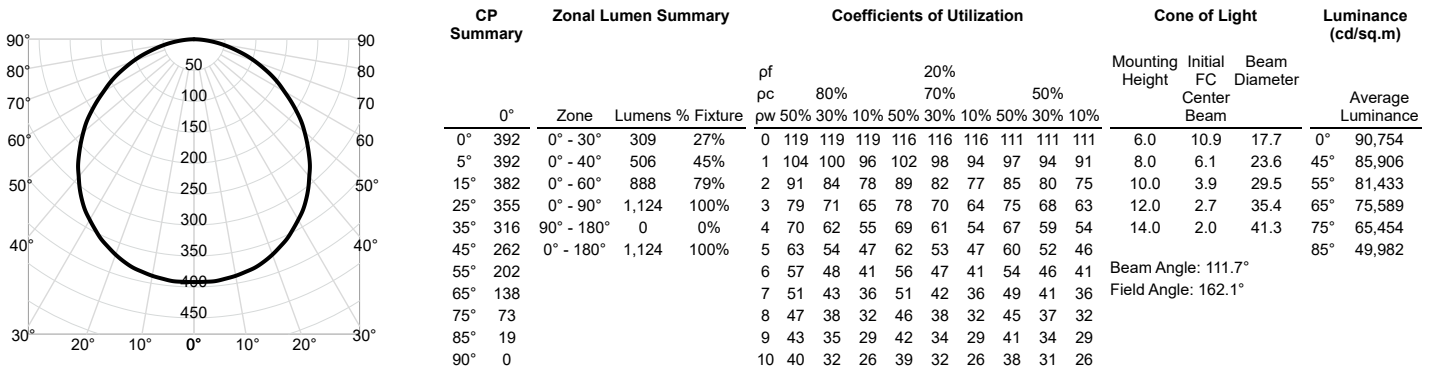

WF4 ALO19 SWW5 90CRI 50K-HI Input Watts: 13.5, Delivered Lumens: 1080, LPW: 80.0, S/MH: 1.27, Test No: ISF 232959P5

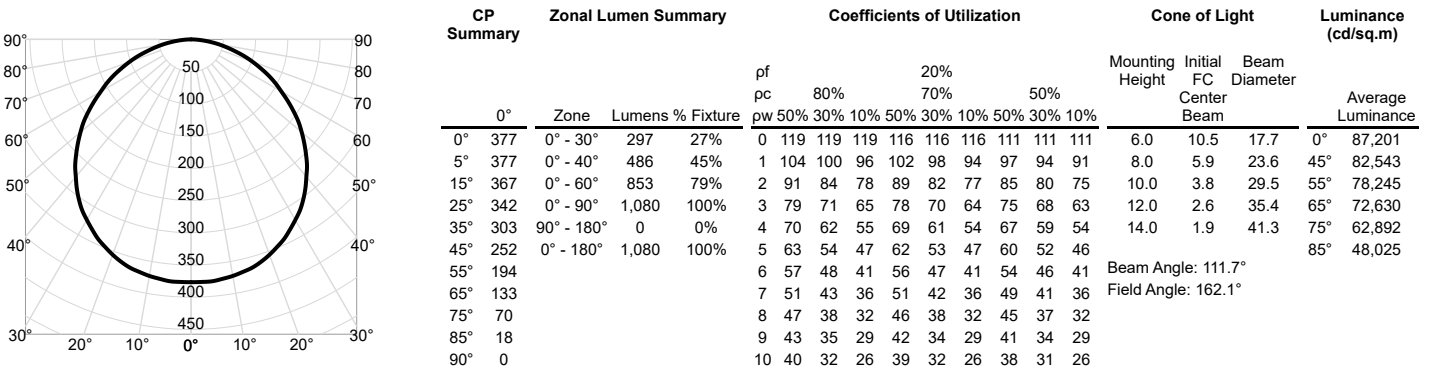

WF4 DREG B ALO19 SWW5 90CRI 27K-HI Input Watts: 12.5, Delivered Lumens: 1019, LPW: 81.5, S/MH: 1.19, Test No: ISF 232976P6

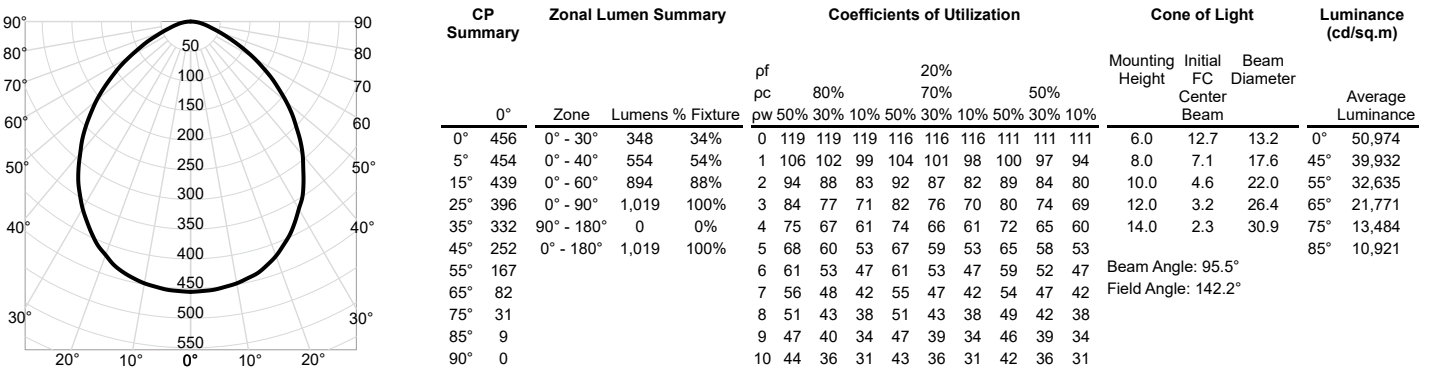



Juno Wafer™ LED Downlight Series

4" & 6" SWW5 + ALO LED Flat & Deep Regressed Wafers

PHOTOMETRICS

Distribution Curve

Distribution Data

Output Data

Coefficient of Utilization

Illuminance Data at 30" Above Floor for a Single Luminaire

WF4 DREG B ALO19 SWW5 90CRI 30K-HI Input Watts: 12.5, Delivered Lumens: 1074, LPW: 85.9, S/MH: 1.19, Test No: ISF 232976P7

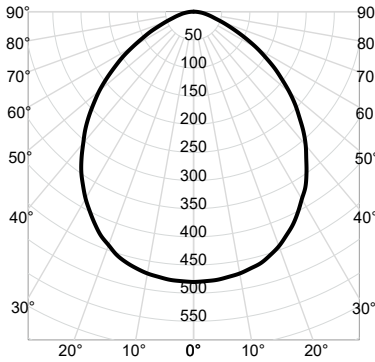

CP Summary		Zonal Lumen Summary		Coefficients of Utilization								Cone of Light			Luminance (cd/sq.m)			
0°	Zone	Lumens	% Fixture	pf pc	80%		20%		50%		Mounting Height	Initial FC Center Beam	Beam Diameter	Average Luminance				
				pw	50%	30%	10%	50%	30%	10%					50%	30%	10%	
0°	0° - 30°	367	34%	0	119	119	119	116	116	116	111	111	111	6.0	13.3	13.2	0°	53,725
5°	0° - 40°	584	54%	1	106	102	99	104	101	98	100	97	94	8.0	7.5	17.6	45°	42,088
15°	0° - 60°	942	88%	2	94	88	83	92	87	82	89	84	80	10.0	4.8	22.0	55°	34,396
25°	0° - 90°	1,074	100%	3	84	77	71	82	76	70	80	74	69	12.0	3.3	26.4	65°	22,946
35°	90° - 180°	0	0%	4	75	67	61	74	66	61	72	65	60	14.0	2.5	30.9	75°	14,212
45°	0° - 180°	1,074	100%	5	68	60	53	67	59	53	65	58	53				85°	11,510
55°		176		6	61	53	47	61	53	47	59	52	47	Beam Angle: 95.5°				
65°		87		7	56	48	42	55	47	42	54	47	42	Field Angle: 142.2°				
75°		33		8	51	43	38	51	43	38	49	42	38					
85°		9		9	47	40	34	47	39	34	46	39	34					
90°		0		10	44	36	31	43	36	31	42	36	31					

WF4 DREG B ALO19 SWW5 90CRI 35K-HI Input Watts: 12.5, Delivered Lumens: 1136, LPW: 90.9, S/MH: 1.19, Test No: ISF 232976P8

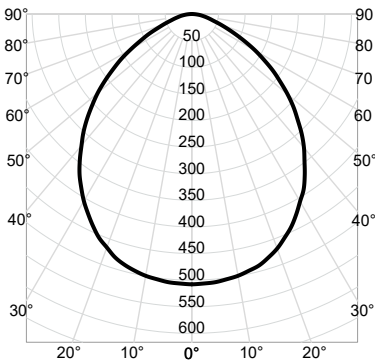

CP Summary		Zonal Lumen Summary		Coefficients of Utilization								Cone of Light			Luminance (cd/sq.m)			
0°	Zone	Lumens	% Fixture	pf pc	80%		20%		50%		Mounting Height	Initial FC Center Beam	Beam Diameter	Average Luminance				
				pw	50%	30%	10%	50%	30%	10%					50%	30%	10%	
0°	0° - 30°	388	34%	0	119	119	119	116	116	116	111	111	111	6.0	14.1	13.2	0°	56,826
5°	0° - 40°	618	54%	1	106	102	99	104	101	98	100	97	94	8.0	7.9	17.6	45°	44,517
15°	0° - 60°	997	88%	2	94	88	83	92	87	82	89	84	80	10.0	5.1	22.0	55°	36,382
25°	0° - 90°	1,136	100%	3	84	77	71	82	76	70	80	74	69	12.0	3.5	26.4	65°	24,270
35°	90° - 180°	0	0%	4	75	67	61	74	66	61	72	65	60	14.0	2.6	30.9	75°	15,032
45°	0° - 180°	1,136	100%	5	68	60	53	67	59	53	65	58	53				85°	12,174
55°		187		6	61	53	47	61	53	47	59	52	47	Beam Angle: 95.5°				
65°		92		7	56	48	42	55	47	42	54	47	42	Field Angle: 142.2°				
75°		35		8	51	43	38	51	43	38	49	42	38					
85°		9		9	47	40	34	47	39	34	46	39	34					
90°		0		10	44	36	31	43	36	31	42	36	31					

WF4 DREG B ALO19 SWW5 90CRI 40K-HI Input Watts: 12.5, Delivered Lumens: 1148, LPW: 91.8, S/MH: 1.19, Test No: ISF 232976P9

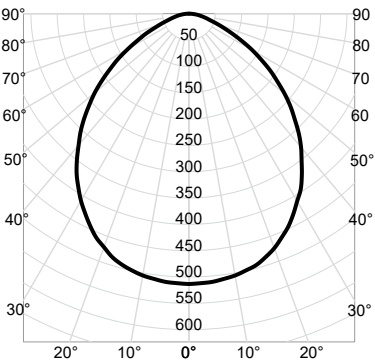

CP Summary		Zonal Lumen Summary		Coefficients of Utilization								Cone of Light			Luminance (cd/sq.m)			
0°	Zone	Lumens	% Fixture	pf pc	80%		20%		50%		Mounting Height	Initial FC Center Beam	Beam Diameter	Average Luminance				
				pw	50%	30%	10%	50%	30%	10%					50%	30%	10%	
0°	0° - 30°	392	34%	0	119	119	119	116	116	116	111	111	111	6.0	14.3	13.2	0°	57,427
5°	0° - 40°	624	54%	1	106	102	99	104	101	98	100	97	94	8.0	8.0	17.6	45°	44,988
15°	0° - 60°	1,007	88%	2	94	88	83	92	87	82	89	84	80	10.0	5.1	22.0	55°	36,766
25°	0° - 90°	1,148	100%	3	84	77	71	82	76	70	80	74	69	12.0	3.6	26.4	65°	24,527
35°	90° - 180°	0	0%	4	75	67	61	74	66	61	72	65	60	14.0	2.6	30.9	75°	15,191
45°	0° - 180°	1,148	100%	5	68	60	53	67	59	53	65	58	53				85°	12,303
55°		188		6	61	53	47	61	53	47	59	52	47	Beam Angle: 95.5°				
65°		93		7	56	48	42	55	47	42	54	47	42	Field Angle: 142.2°				
75°		35		8	51	43	38	51	43	38	49	42	38					
85°		10		9	47	40	34	47	39	34	46	39	34					
90°		0		10	44	36	31	43	36	31	42	36	31					



Juno Wafer™ LED Downlight Series

4" & 6" SWW5 + ALO LED Flat & Deep Regressed Wafers

PHOTOMETRICS

Distribution Curve

Distribution Data

Output Data

Coefficient of Utilization

Illuminance Data at 30" Above Floor for a Single Luminaire

WF4 DREG B ALO19 SWW5 90CRI 50K-HI Input Watts: 12.5, Delivered Lumens: 1109, LPW: 88.7, S/MH: 1.19, Test No: ISF 232976P10

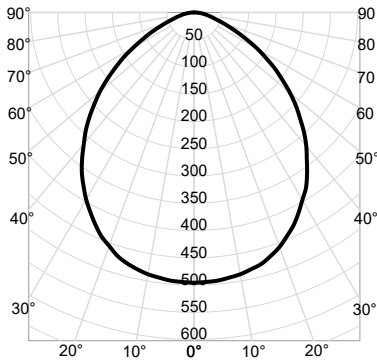

CP Summary				Zonal Lumen Summary				Coefficients of Utilization										Cone of Light			Luminance (cd/sq.m)	
0°	Zone	Lumens	% Fixture	pf pc	80%		20%		70%		50%		Mounting Height	Initial FC Center Beam	Beam Diameter	Average Luminance	0°	45°	55°			
					50%	30%	10%	50%	30%	10%	50%	30%								10%		
0°	0° - 30°	379	34%	0	119	119	119	116	116	116	111	111	111	6.0	13.8	13.2	0°	55,476				
5°	0° - 40°	603	54%	1	106	102	99	104	101	98	100	97	94	8.0	7.7	17.6	45°	43,459				
15°	0° - 60°	973	88%	2	94	88	83	92	87	82	89	84	80	10.0	5.0	22.0	55°	35,517				
25°	0° - 90°	1,109	100%	3	84	77	71	82	76	70	80	74	69	12.0	3.4	26.4	65°	23,693				
35°	90° - 180°	0	0%	4	75	67	61	74	66	61	72	65	60	14.0	2.5	30.9	75°	14,675				
45°	0° - 180°	1,109	100%	5	68	60	53	67	59	53	65	58	53				85°	11,885				
55°		182		6	61	53	47	61	53	47	59	52	47									
65°		90		7	56	48	42	55	47	42	54	47	42									
75°		34		8	51	43	38	51	43	38	49	42	38									
85°		9		9	47	40	34	47	39	34	46	39	34									
90°		0		10	44	36	31	43	36	31	42	36	31									

Beam Angle: 95.5°
Field Angle: 142.2°

WF4 DREG SM ALO19 SWW5 90CRI 27K Input Watts: 12.5, Delivered Lumens: 1019, LPW: 81.5, S/MH: 1.19, Test No: ISF 232976P1

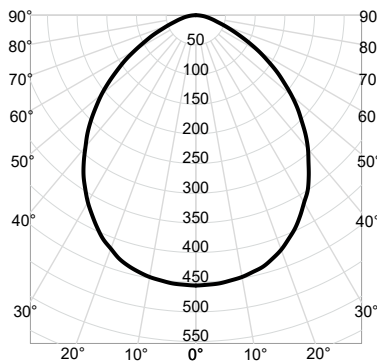

CP Summary				Zonal Lumen Summary				Coefficients of Utilization										Cone of Light			Luminance (cd/sq.m)	
0°	Zone	Lumens	% Fixture	pf pc	80%		20%		70%		50%		Mounting Height	Initial FC Center Beam	Beam Diameter	Average Luminance	0°	45°	55°			
					50%	30%	10%	50%	30%	10%	50%	30%								10%		
0°	0° - 30°	348	34%	0	119	119	119	116	116	116	111	111	111	6.0	12.7	13.2	0°	50,974				
5°	0° - 40°	554	54%	1	106	102	99	104	101	98	100	97	94	8.0	7.1	17.6	45°	39,932				
15°	0° - 60°	894	88%	2	94	88	83	92	87	82	89	84	80	10.0	4.6	22.0	55°	32,635				
25°	0° - 90°	1,019	100%	3	84	77	71	82	76	70	80	74	69	12.0	3.2	26.4	65°	21,771				
35°	90° - 180°	0	0%	4	75	67	61	74	66	61	72	65	60	14.0	2.3	30.9	75°	13,484				
45°	0° - 180°	1,019	100%	5	68	60	53	67	59	53	65	58	53				85°	10,921				
55°		167		6	61	53	47	61	53	47	59	52	47									
65°		82		7	56	48	42	55	47	42	54	47	42									
75°		31		8	51	43	38	51	43	38	49	42	38									
85°		9		9	47	40	34	47	39	34	46	39	34									
90°		0		10	44	36	31	43	36	31	42	36	31									

Beam Angle: 95.5°
Field Angle: 142.2°

WF4 DREG SM ALO19 SWW5 90CRI 30K Input Watts: 12.5, Delivered Lumens: 1074, LPW: 85.9, S/MH: 1.19, Test No: ISF 232976P2

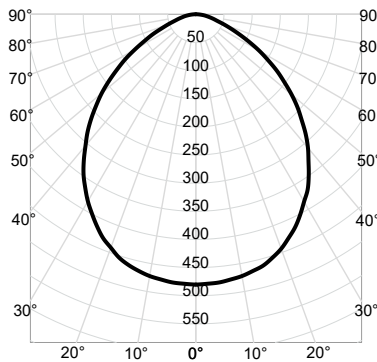

CP Summary				Zonal Lumen Summary				Coefficients of Utilization										Cone of Light			Luminance (cd/sq.m)	
0°	Zone	Lumens	% Fixture	pf pc	80%		20%		70%		50%		Mounting Height	Initial FC Center Beam	Beam Diameter	Average Luminance	0°	45°	55°			
					50%	30%	10%	50%	30%	10%	50%	30%								10%		
0°	0° - 30°	367	34%	0	119	119	119	116	116	116	111	111	111	6.0	13.3	13.2	0°	53,725				
5°	0° - 40°	584	54%	1	106	102	99	104	101	98	100	97	94	8.0	7.5	17.6	45°	42,088				
15°	0° - 60°	942	88%	2	94	88	83	92	87	82	89	84	80	10.0	4.8	22.0	55°	34,396				
25°	0° - 90°	1,074	100%	3	84	77	71	82	76	70	80	74	69	12.0	3.3	26.4	65°	22,946				
35°	90° - 180°	0	0%	4	75	67	61	74	66	61	72	65	60	14.0	2.5	30.9	75°	14,212				
45°	0° - 180°	1,074	100%	5	68	60	53	67	59	53	65	58	53				85°	11,510				
55°		176		6	61	53	47	61	53	47	59	52	47									
65°		87		7	56	48	42	55	47	42	54	47	42									
75°		33		8	51	43	38	51	43	38	49	42	38									
85°		9		9	47	40	34	47	39	34	46	39	34									
90°		0		10	44	36	31	43	36	31	42	36	31									

Beam Angle: 95.5°
Field Angle: 142.2°



Juno Wafer™ LED Downlight Series

4" & 6" SWW5 + ALO LED Flat & Deep Regressed Wafers

PHOTOMETRICS

Distribution Curve

Distribution Data

Output Data

Coefficient of Utilization

Illuminance Data at 30" Above Floor for a Single Luminaire

WF4 DREG SM ALO19 SWW5 90CRI 35K Input Watts: 12.5, Delivered Lumens: 1136, LPW: 90.9, S/MH: 1.19, Test No: ISF 232976P3

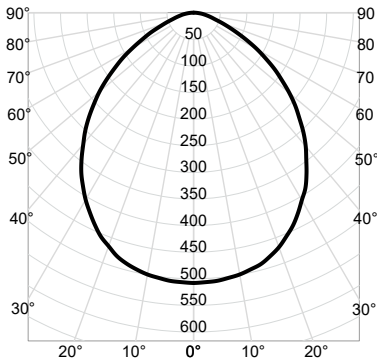

CP Summary		Zonal Lumen Summary		Coefficients of Utilization						Cone of Light			Luminance (cd/sq.m)					
0°	Zone	Lumens	% Fixture	pf pc	80%		20%		50%		Mounting Height	Initial FC Center Beam	Beam Diameter	Average Luminance				
					50%	30%	10%	50%	30%	10%								
0°	0° - 30°	388	34%	0	119	119	119	116	116	116	111	111	111	6.0	14.1	13.2	0°	56,826
5°	0° - 40°	618	54%	1	106	102	99	104	101	98	100	97	94	8.0	7.9	17.6	45°	44,517
15°	0° - 60°	997	88%	2	94	88	83	92	87	82	89	84	80	10.0	5.1	22.0	55°	36,382
25°	0° - 90°	1,136	100%	3	84	77	71	82	76	70	80	74	69	12.0	3.5	26.4	65°	24,270
35°	90° - 180°	0	0%	4	75	67	61	74	66	61	72	65	60	14.0	2.6	30.9	75°	15,032
45°	0° - 180°	1,136	100%	5	68	60	53	67	59	53	65	58	53				85°	12,174
55°				6	61	53	47	61	53	47	59	52	47					
65°				7	56	48	42	55	47	42	54	47	42					
75°				8	51	43	38	51	43	38	49	42	38					
85°				9	47	40	34	47	39	34	46	39	34					
90°				10	44	36	31	43	36	31	42	36	31					

WF4 DREG SM ALO19 SWW5 90CRI 40K Input Watts: 12.5, Delivered Lumens: 1148, LPW: 91.8, S/MH: 1.19, Test No: ISF 232976P4

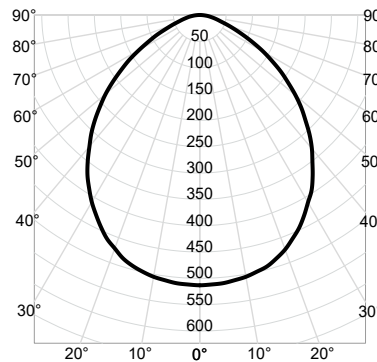

CP Summary		Zonal Lumen Summary		Coefficients of Utilization						Cone of Light			Luminance (cd/sq.m)					
0°	Zone	Lumens	% Fixture	pf pc	80%		20%		50%		Mounting Height	Initial FC Center Beam	Beam Diameter	Average Luminance				
					50%	30%	10%	50%	30%	10%								
0°	0° - 30°	392	34%	0	119	119	119	116	116	116	111	111	111	6.0	14.3	13.2	0°	57,427
5°	0° - 40°	624	54%	1	106	102	99	104	101	98	100	97	94	8.0	8.0	17.6	45°	44,988
15°	0° - 60°	1,007	88%	2	94	88	83	92	87	82	89	84	80	10.0	5.1	22.0	55°	36,766
25°	0° - 90°	1,148	100%	3	84	77	71	82	76	70	80	74	69	12.0	3.6	26.4	65°	24,527
35°	90° - 180°	0	0%	4	75	67	61	74	66	61	72	65	60	14.0	2.6	30.9	75°	15,191
45°	0° - 180°	1,148	100%	5	68	60	53	67	59	53	65	58	53				85°	12,303
55°				6	61	53	47	61	53	47	59	52	47					
65°				7	56	48	42	55	47	42	54	47	42					
75°				8	51	43	38	51	43	38	49	42	38					
85°				9	47	40	34	47	39	34	46	39	34					
90°				10	44	36	31	43	36	31	42	36	31					

WF4 DREG SM ALO19 SWW5 90CRI 50K Input Watts: 12.5, Delivered Lumens: 1109, LPW: 88.7, S/MH: 1.19, Test No: ISF 232976P5

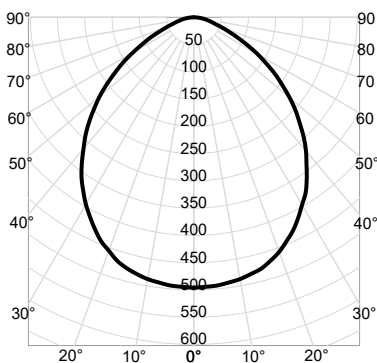

CP Summary		Zonal Lumen Summary		Coefficients of Utilization						Cone of Light			Luminance (cd/sq.m)					
0°	Zone	Lumens	% Fixture	pf pc	80%		20%		50%		Mounting Height	Initial FC Center Beam	Beam Diameter	Average Luminance				
					50%	30%	10%	50%	30%	10%								
0°	0° - 30°	379	34%	0	119	119	119	116	116	116	111	111	111	6.0	13.8	13.2	0°	55,476
5°	0° - 40°	603	54%	1	106	102	99	104	101	98	100	97	94	8.0	7.7	17.6	45°	43,459
15°	0° - 60°	973	88%	2	94	88	83	92	87	82	89	84	80	10.0	5.0	22.0	55°	35,517
25°	0° - 90°	1,109	100%	3	84	77	71	82	76	70	80	74	69	12.0	3.4	26.4	65°	23,693
35°	90° - 180°	0	0%	4	75	67	61	74	66	61	72	65	60	14.0	2.5	30.9	75°	14,675
45°	0° - 180°	1,109	100%	5	68	60	53	67	59	53	65	58	53				85°	11,885
55°				6	61	53	47	61	53	47	59	52	47					
65°				7	56	48	42	55	47	42	54	47	42					
75°				8	51	43	38	51	43	38	49	42	38					
85°				9	47	40	34	47	39	34	46	39	34					
90°				10	44	36	31	43	36	31	42	36	31					



Juno Wafer™ LED Downlight Series

4" & 6" SWW5 + ALO LED Flat & Deep Regressed Wafers

PHOTOMETRICS

Distribution Curve

Distribution Data

Output Data

Coefficient of Utilization

Illuminance Data at 30" Above Floor for a Single Luminaire

WF6 ALO20 SWW5 90CRI 27K Input Watts: 15.0, Delivered Lumens: 1209, LPW: 80.6, S/MH: 1.25, Test No: ISF 232965P1

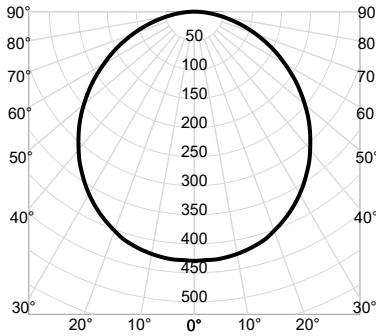

CP Summary	Zonal Lumen Summary				Coefficients of Utilization										Cone of Light			Luminance (cd/sq.m)	
	0°	Zone	Lumens	% Fixture	pw	80%		20%		70%		50%		Mounting Height	Initial FC Center Beam	Beam Diameter	Average Luminance		
						50%	30%	10%	50%	30%	10%	50%	30%					10%	
	0°	0° - 30°	335	28%	0	119	119	119	116	116	116	111	111	111	6.0	11.9	17.2	0°	35,591
	5°	0° - 40°	547	45%	1	104	100	96	102	98	94	97	94	91	8.0	6.7	22.9	45°	32,906
	15°	0° - 60°	955	79%	2	91	84	78	89	82	77	85	80	75	10.0	4.3	28.6	55°	31,092
	25°	0° - 90°	1,209	100%	3	79	71	65	78	70	64	75	68	63	12.0	3.0	34.4	65°	28,796
	35°	90° - 180°	0	0%	4	70	62	55	69	61	55	67	59	54	14.0	2.2	40.1	75°	25,433
	45°	0° - 180°	1,209	100%	5	63	54	47	62	53	47	60	52	47				85°	21,077
	55°		215		6	57	48	41	56	47	41	54	46	41					
	65°		147		7	51	43	36	51	42	36	49	42	36					
	75°		79		8	47	38	33	46	38	32	45	38	32					
	85°		22		9	43	35	29	43	35	29	41	34	29					
	90°		1		10	40	32	27	39	32	27	38	31	26					

Beam Angle: 110.1°
Field Angle: 162.2°

WF6 ALO20 SWW5 90CRI 30K Input Watts: 15.0, Delivered Lumens: 1239, LPW: 82.6, S/MH: 1.25, Test No: ISF 232965P2

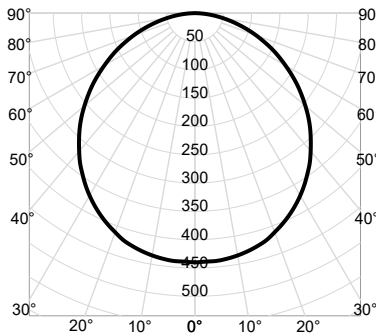

CP Summary	Zonal Lumen Summary				Coefficients of Utilization										Cone of Light			Luminance (cd/sq.m)	
	0°	Zone	Lumens	% Fixture	pw	80%		20%		70%		50%		Mounting Height	Initial FC Center Beam	Beam Diameter	Average Luminance		
						50%	30%	10%	50%	30%	10%	50%	30%					10%	
	0°	0° - 30°	344	28%	0	119	119	119	116	116	116	111	111	111	6.0	12.2	17.2	0°	36,474
	5°	0° - 40°	560	45%	1	104	100	96	102	98	94	97	94	91	8.0	6.9	22.9	45°	33,723
	15°	0° - 60°	978	79%	2	91	84	78	89	82	77	85	80	75	10.0	4.4	28.6	55°	31,864
	25°	0° - 90°	1,239	100%	3	79	71	65	78	70	64	75	68	63	12.0	3.1	34.4	65°	29,511
	35°	90° - 180°	0	0%	4	70	62	55	69	61	55	67	59	54	14.0	2.2	40.1	75°	26,064
	45°	0° - 180°	1,239	100%	5	63	54	47	62	53	47	60	52	47				85°	21,600
	55°		221		6	57	48	41	56	47	41	54	46	41					
	65°		150		7	51	43	36	51	42	36	49	42	36					
	75°		81		8	47	38	33	46	38	32	45	38	32					
	85°		23		9	43	35	29	43	35	29	41	34	29					
	90°		1		10	40	32	27	39	32	27	38	31	26					

Beam Angle: 110.1°
Field Angle: 162.2°

WF6 ALO20 SWW5 90CRI 35K Input Watts: 15.0, Delivered Lumens: 1299, LPW: 86.6, S/MH: 1.25, Test No: ISF 232965P3

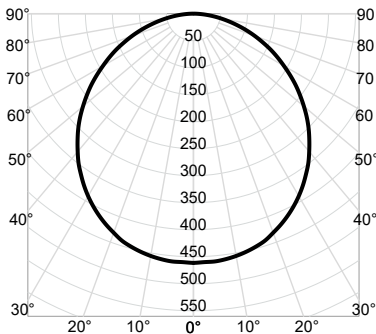

CP Summary	Zonal Lumen Summary				Coefficients of Utilization										Cone of Light			Luminance (cd/sq.m)	
	0°	Zone	Lumens	% Fixture	pw	80%		20%		70%		50%		Mounting Height	Initial FC Center Beam	Beam Diameter	Average Luminance		
						50%	30%	10%	50%	30%	10%	50%	30%					10%	
	0°	0° - 30°	360	28%	0	119	119	119	116	116	116	111	111	111	6.0	12.8	17.2	0°	38,241
	5°	0° - 40°	587	45%	1	104	100	96	102	98	94	97	94	91	8.0	7.2	22.9	45°	35,356
	15°	0° - 60°	1,026	79%	2	91	84	78	89	82	77	85	80	75	10.0	4.6	28.6	55°	33,407
	25°	0° - 90°	1,299	100%	3	79	71	65	78	70	64	75	68	63	12.0	3.2	34.4	65°	30,940
	35°	90° - 180°	0	0%	4	70	62	55	69	61	55	67	59	54	14.0	2.4	40.1	75°	27,326
	45°	0° - 180°	1,299	100%	5	63	54	47	62	53	47	60	52	47				85°	22,646
	55°		231		6	57	48	41	56	47	41	54	46	41					
	65°		158		7	51	43	36	51	42	36	49	42	36					
	75°		85		8	47	38	33	46	38	32	45	38	32					
	85°		24		9	43	35	29	43	35	29	41	34	29					
	90°		1		10	40	32	27	39	32	27	38	31	26					

Beam Angle: 110.1°
Field Angle: 162.2°



Juno Wafer™ LED Downlight Series

4" & 6" SWW5 + ALO LED Flat & Deep Regressed Wafers

PHOTOMETRICS

Distribution Curve

Distribution Data

Output Data

Coefficient of Utilization

Illuminance Data at 30" Above Floor for a Single Luminaire

WF6 ALO20 SWW5 90CRI 40K Input Watts: 15.0, Delivered Lumens: 1306, LPW: 87.1, S/MH: 1.25, Test No: ISF 232965P4

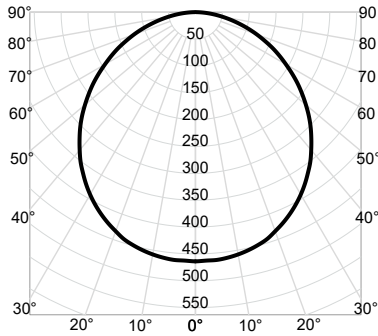

CP Summary				Zonal Lumen Summary				Coefficients of Utilization						Cone of Light			Luminance (cd/sq.m)		
0°	Zone	Lumens	% Fixture	pf pc	80%	20%	50%	80%	70%	50%	10%	50%	30%	10%	Mounting Height	Initial FC Center Beam	Beam Diameter	Average Luminance	
0°	464	0° - 30°	362	28%	0	119	119	119	116	116	116	111	111	111	6.0	12.9	17.2	0°	38,447
5°	463	0° - 40°	591	45%	1	104	100	96	102	98	94	97	94	91	8.0	7.2	22.9	45°	35,546
15°	449	0° - 60°	1,031	79%	2	91	84	78	89	82	77	85	80	75	10.0	4.6	28.6	55°	33,587
25°	415	0° - 90°	1,306	100%	3	79	71	65	78	70	64	75	68	63	12.0	3.2	34.4	65°	31,107
35°	365	90° - 180°	0	0%	4	70	62	55	69	61	55	67	59	54	14.0	2.4	40.1	75°	27,473
45°	303	0° - 180°	1,306	100%	5	63	54	47	62	53	47	60	52	47	Beam Angle: 110.1° Field Angle: 162.2°				
55°	232			6	57	48	41	56	47	41	54	46	41						
65°	159			7	51	43	36	51	42	36	49	42	36						
75°	86			8	47	38	33	46	38	32	45	38	32						
85°	24			9	43	35	29	43	35	29	41	34	29						
90°	1			10	40	32	27	39	32	27	38	31	26						

WF6 ALO20 SWW5 90CRI 50K Input Watts: 15.0, Delivered Lumens: 1289, LPW: 85.9, S/MH: 1.25, Test No: ISF 232965P5

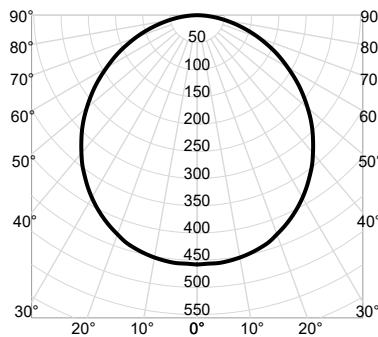

CP Summary				Zonal Lumen Summary				Coefficients of Utilization						Cone of Light			Luminance (cd/sq.m)		
0°	Zone	Lumens	% Fixture	pf pc	80%	20%	50%	80%	70%	50%	10%	50%	30%	10%	Mounting Height	Initial FC Center Beam	Beam Diameter	Average Luminance	
0°	458	0° - 30°	358	28%	0	119	119	119	116	116	116	111	111	111	6.0	12.7	17.2	0°	37,946
5°	457	0° - 40°	583	45%	1	104	100	96	102	98	94	97	94	91	8.0	7.2	22.9	45°	35,084
15°	443	0° - 60°	1,018	79%	2	91	84	78	89	82	77	85	80	75	10.0	4.6	28.6	55°	33,150
25°	410	0° - 90°	1,289	100%	3	79	71	65	78	70	64	75	68	63	12.0	3.2	34.4	65°	30,702
35°	360	90° - 180°	0	0%	4	70	62	55	69	61	55	67	59	54	14.0	2.3	40.1	75°	27,116
45°	299	0° - 180°	1,289	100%	5	63	54	47	62	53	47	60	52	47	Beam Angle: 110.1° Field Angle: 162.2°				
55°	229			6	57	48	41	56	47	41	54	46	41						
65°	157			7	51	43	36	51	42	36	49	42	36						
75°	85			8	47	38	33	46	38	32	45	38	32						
85°	24			9	43	35	29	43	35	29	41	34	29						
90°	1			10	40	32	27	39	32	27	38	31	26						

WF6 DREG B ALO20 SWW5 90CRI 27K Input Watts: 15.5, Delivered Lumens: 1297, LPW: 83.7, S/MH: 1.21, Test No: ISF 233012P6

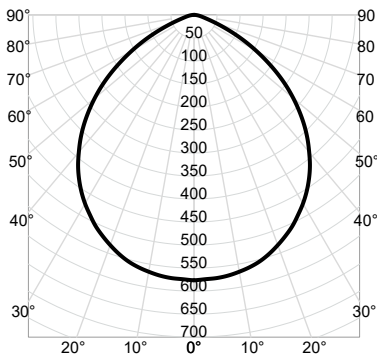

CP Summary				Zonal Lumen Summary				Coefficients of Utilization						Cone of Light			Luminance (cd/sq.m)		
0°	Zone	Lumens	% Fixture	pf pc	80%	20%	50%	80%	70%	50%	10%	50%	30%	10%	Mounting Height	Initial FC Center Beam	Beam Diameter	Average Luminance	
0°	577	0° - 30°	444	34%	0	119	119	119	116	116	116	111	111	111	6.0	16.0	14.0	0°	35,770
5°	574	0° - 40°	715	55%	1	107	103	100	105	101	99	100	98	95	8.0	9.0	18.7	45°	29,701
15°	554	0° - 60°	1,170	90%	2	95	89	84	93	88	83	90	85	82	10.0	5.8	23.3	55°	23,790
25°	506	0° - 90°	1,297	100%	3	85	78	72	83	77	71	80	75	70	12.0	4.0	28.0	65°	13,951
35°	435	90° - 180°	0	0%	4	76	68	62	75	67	62	72	66	61	14.0	2.9	32.7	75°	5,207
45°	339	0° - 180°	1,297	100%	5	69	60	54	67	60	54	65	59	54	Beam Angle: 98.8° Field Angle: 137.4°				
55°	220			6	62	54	48	61	53	48	59	53	47						
65°	95			7	57	48	43	56	48	43	54	47	42						
75°	22			8	52	44	38	51	44	38	50	43	38						
85°	5			9	48	40	35	47	40	35	46	39	34						
90°	0			10	44	37	32	44	36	32	43	36	31						



Juno Wafer™ LED Downlight Series

4" & 6" SWW5 + ALO LED Flat & Deep Regressed Wafers

PHOTOMETRICS

Distribution Curve

Distribution Data

Output Data

Coefficient of Utilization

Illuminance Data at 30" Above Floor for a Single Luminaire

WF6 DREG B ALO20 SWW5 90CRI 30K Input Watts: 15.5, Delivered Lumens: 1409, LPW: 90.9, S/MH: 1.21, Test No: ISF 233012P7

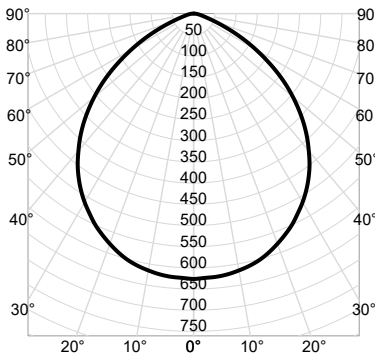

CP Summary		Zonal Lumen Summary		Coefficients of Utilization								Cone of Light			Luminance (cd/sq.m)			
0°	Zone	Lumens	% Fixture	pf	80%			20%			50%		Mounting Height	Initial FC Center Beam	Beam Diameter	Average Luminance		
				pc	50%	30%	10%	50%	30%	10%	50%	30%					10%	
0°	0° - 30°	482	34%	0	119	119	119	116	116	116	111	111	111	6.0	17.4	14.0	0°	38,859
5°	0° - 40°	777	55%	1	107	103	100	105	101	99	100	98	95	8.0	9.8	18.7	45°	32,265
15°	0° - 60°	1,271	90%	2	95	89	84	93	88	83	90	85	82	10.0	6.3	23.3	55°	25,844
25°	0° - 90°	1,409	100%	3	85	78	72	83	77	71	80	75	70	12.0	4.3	28.0	65°	15,156
35°	90° - 180°	0	0%	4	76	68	62	75	67	62	72	66	61	14.0	3.2	32.7	75°	5,657
45°	0° - 180°	1,409	100%	5	69	60	54	67	60	54	65	59	54	Beam Angle: 98.8°			85°	3,500
55°				6	62	54	48	61	53	48	59	53	47	Field Angle: 137.4°				
65°				7	57	48	43	56	48	43	54	47	42					
75°				8	52	44	38	51	44	38	50	43	38					
85°				9	48	40	35	47	40	35	46	39	34					
90°				10	44	37	32	44	36	32	43	36	31					

WF6 DREG B ALO20 SWW5 90CRI 35K Input Watts: 15.5, Delivered Lumens: 1489, LPW: 96.1, S/MH: 1.21, Test No: ISF 233012P8

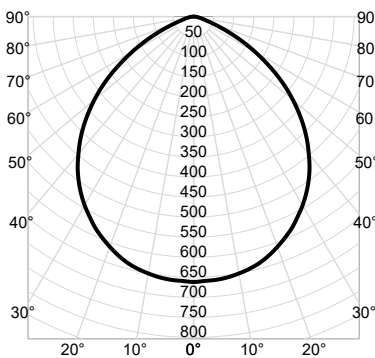

CP Summary		Zonal Lumen Summary		Coefficients of Utilization								Cone of Light			Luminance (cd/sq.m)			
0°	Zone	Lumens	% Fixture	pf	80%			20%			50%		Mounting Height	Initial FC Center Beam	Beam Diameter	Average Luminance		
				pc	50%	30%	10%	50%	30%	10%	50%	30%					10%	
0°	0° - 30°	509	34%	0	119	119	119	116	116	116	111	111	111	6.0	18.4	14.0	0°	41,065
5°	0° - 40°	821	55%	1	107	103	100	105	101	99	100	98	95	8.0	10.3	18.7	45°	34,097
15°	0° - 60°	1,343	90%	2	95	89	84	93	88	83	90	85	82	10.0	6.6	23.3	55°	27,312
25°	0° - 90°	1,489	100%	3	85	78	72	83	77	71	80	75	70	12.0	4.6	28.0	65°	16,017
35°	90° - 180°	0	0%	4	76	68	62	75	67	62	72	66	61	14.0	3.4	32.7	75°	5,978
45°	0° - 180°	1,489	100%	5	69	60	54	67	60	54	65	59	54	Beam Angle: 98.8°			85°	3,698
55°				6	62	54	48	61	53	48	59	53	47	Field Angle: 137.4°				
65°				7	57	48	43	56	48	43	54	47	42					
75°				8	52	44	38	51	44	38	50	43	38					
85°				9	48	40	35	47	40	35	46	39	34					
90°				10	44	37	32	44	36	32	43	36	31					

WF6 DREG B ALO20 SWW5 90CRI 40K Input Watts: 15.5, Delivered Lumens: 1500, LPW: 96.8, S/MH: 1.21, Test No: ISF 233012P9

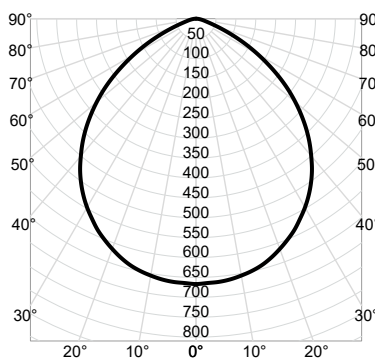

CP Summary		Zonal Lumen Summary		Coefficients of Utilization								Cone of Light			Luminance (cd/sq.m)			
0°	Zone	Lumens	% Fixture	pf	80%			20%			50%		Mounting Height	Initial FC Center Beam	Beam Diameter	Average Luminance		
				pc	50%	30%	10%	50%	30%	10%	50%	30%					10%	
0°	0° - 30°	513	34%	0	119	119	119	116	116	116	111	111	111	6.0	18.5	14.0	0°	41,368
5°	0° - 40°	827	55%	1	107	103	100	105	101	99	100	98	95	8.0	10.4	18.7	45°	34,349
15°	0° - 60°	1,353	90%	2	95	89	84	93	88	83	90	85	82	10.0	6.7	23.3	55°	27,513
25°	0° - 90°	1,500	100%	3	85	78	72	83	77	71	80	75	70	12.0	4.6	28.0	65°	16,135
35°	90° - 180°	0	0%	4	76	68	62	75	67	62	72	66	61	14.0	3.4	32.7	75°	6,022
45°	0° - 180°	1,500	100%	5	69	60	54	67	60	54	65	59	54	Beam Angle: 98.8°			85°	3,726
55°				6	62	54	48	61	53	48	59	53	47	Field Angle: 137.4°				
65°				7	57	48	43	56	48	43	54	47	42					
75°				8	52	44	38	51	44	38	50	43	38					
85°				9	48	40	35	47	40	35	46	39	34					
90°				10	44	37	32	44	36	32	43	36	31					



Juno Wafer™ LED Downlight Series

4" & 6" SWW5 + ALO LED Flat & Deep Regressed Wafers

PHOTOMETRICS

Distribution Curve

Distribution Data

Output Data

Coefficient of Utilization

Illuminance Data at 30" Above Floor for a Single Luminaire

WF6 DREG B ALO20 SWW5 90CRI 50K Input Watts: 15.5, Delivered Lumens: 1412, LPW: 91.1, S/MH: 1.21, Test No: ISF 233012P10

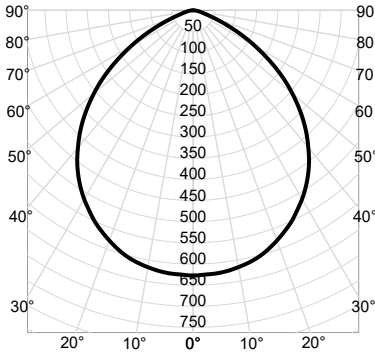

CP Summary		Zonal Lumen Summary		Coefficients of Utilization						Cone of Light			Luminance (cd/sq.m)					
0°	Zone	Lumens	% Fixture	pf pc	80%	10%	20%	30%	50%	10%	50%	30%	10%	Mounting Height	Initial FC Center Beam	Beam Diameter	Average Luminance	
0°	0° - 30°	483	34%	0	119	119	119	116	116	116	111	111	111	6.0	17.4	14.0	0°	38,941
5°	0° - 40°	778	55%	1	107	103	100	105	101	99	100	98	95	8.0	9.8	18.7	45°	32,334
15°	0° - 60°	1,274	90%	2	95	89	84	93	88	83	90	85	82	10.0	6.3	23.3	55°	25,899
25°	0° - 90°	1,412	100%	3	85	78	72	83	77	71	80	75	70	12.0	4.4	28.0	65°	15,188
35°	90° - 180°	0	0%	4	76	68	62	75	67	62	72	66	61	14.0	3.2	32.7	75°	5,669
45°	0° - 180°	1,412	100%	5	69	60	54	67	60	54	65	59	54	Beam Angle: 98.8°			85°	3,507
55°		239		6	62	54	48	61	53	48	59	53	47	Field Angle: 137.4°				
65°		103		7	57	48	43	56	48	43	54	47	42					
75°		24		8	52	44	38	51	44	38	50	43	38					
85°		5		9	48	40	35	47	40	35	46	39	34					
90°		0		10	44	37	32	44	36	32	43	36	31					

WF6 DREG SM ALO20 SWW5 90CRI 27K Input Watts: 15.5, Delivered Lumens: 1297, LPW: 83.7, S/MH: 1.21, Test No: ISF 233012P1

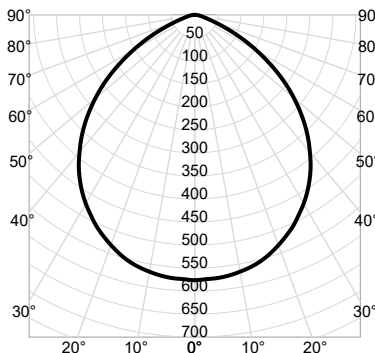

CP Summary		Zonal Lumen Summary		Coefficients of Utilization						Cone of Light			Luminance (cd/sq.m)					
0°	Zone	Lumens	% Fixture	pf pc	80%	10%	20%	30%	50%	10%	50%	30%	10%	Mounting Height	Initial FC Center Beam	Beam Diameter	Average Luminance	
0°	0° - 30°	444	34%	0	119	119	119	116	116	116	111	111	111	6.0	16.0	14.0	0°	35,770
5°	0° - 40°	715	55%	1	107	103	100	105	101	99	100	98	95	8.0	9.0	18.7	45°	29,701
15°	0° - 60°	1,170	90%	2	95	89	84	93	88	83	90	85	82	10.0	5.8	23.3	55°	23,790
25°	0° - 90°	1,297	100%	3	85	78	72	83	77	71	80	75	70	12.0	4.0	28.0	65°	13,951
35°	90° - 180°	0	0%	4	76	68	62	75	67	62	72	66	61	14.0	2.9	32.7	75°	5,207
45°	0° - 180°	1,297	100%	5	69	60	54	67	60	54	65	59	54	Beam Angle: 98.8°			85°	3,221
55°		220		6	62	54	48	61	53	48	59	53	47	Field Angle: 137.4°				
65°		95		7	57	48	43	56	48	43	54	47	42					
75°		22		8	52	44	38	51	44	38	50	43	38					
85°		5		9	48	40	35	47	40	35	46	39	34					
90°		0		10	44	37	32	44	36	32	43	36	31					

WF6 DREG SM ALO20 SWW5 90CRI 30K Input Watts: 15.5, Delivered Lumens: 1409, LPW: 90.9, S/MH: 1.21, Test No: ISF 233012P2

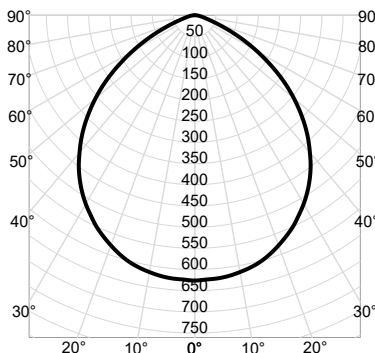

CP Summary		Zonal Lumen Summary		Coefficients of Utilization						Cone of Light			Luminance (cd/sq.m)					
0°	Zone	Lumens	% Fixture	pf pc	80%	10%	20%	30%	50%	10%	50%	30%	10%	Mounting Height	Initial FC Center Beam	Beam Diameter	Average Luminance	
0°	0° - 30°	482	34%	0	119	119	119	116	116	116	111	111	111	6.0	17.4	14.0	0°	38,859
5°	0° - 40°	777	55%	1	107	103	100	105	101	99	100	98	95	8.0	9.8	18.7	45°	32,265
15°	0° - 60°	1,271	90%	2	95	89	84	93	88	83	90	85	82	10.0	6.3	23.3	55°	25,844
25°	0° - 90°	1,409	100%	3	85	78	72	83	77	71	80	75	70	12.0	4.3	28.0	65°	15,156
35°	90° - 180°	0	0%	4	76	68	62	75	67	62	72	66	61	14.0	3.2	32.7	75°	5,657
45°	0° - 180°	1,409	100%	5	69	60	54	67	60	54	65	59	54	Beam Angle: 98.8°			85°	3,500
55°		239		6	62	54	48	61	53	48	59	53	47	Field Angle: 137.4°				
65°		103		7	57	48	43	56	48	43	54	47	42					
75°		24		8	52	44	38	51	44	38	50	43	38					
85°		5		9	48	40	35	47	40	35	46	39	34					
90°		0		10	44	37	32	44	36	32	43	36	31					



Juno Wafer™ LED Downlight Series

4" & 6" SWW5 + ALO LED Flat & Deep Regressed Wafers

PHOTOMETRICS

Distribution Curve

Distribution Data

Output Data

Coefficient of Utilization

Illuminance Data at 30" Above Floor for a Single Luminaire

WF6 DREG SM ALO20 SWW5 90CRI 35K Input Watts: 15.5, Delivered Lumens: 1489, LPW: 96.1, S/MH: 1.21, Test No: ISF 233012P3

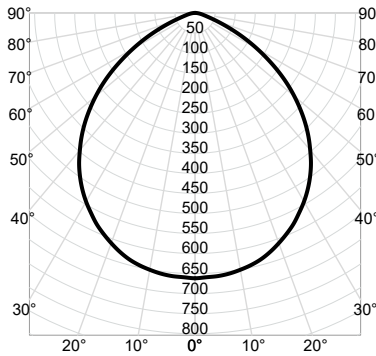

CP Summary	Zonal Lumen Summary				Coefficients of Utilization										Cone of Light			Luminance (cd/sq.m)		
	0°	Zone	Lumens	% Fixture	pf	pc	80%			20%			50%				Mounting Height	Initial FC Center Beam	Beam Diameter	Average Luminance
							50%	30%	10%	50%	30%	10%	50%	30%	10%					
0°	0° - 30°	509	34%	0	119	119	119	116	116	116	111	111	111	6.0	18.4	14.0	0°	41,065		
5°	0° - 40°	821	55%	1	107	103	100	105	101	99	100	98	95	8.0	10.3	18.7	45°	34,097		
15°	0° - 60°	1,343	90%	2	95	89	84	93	88	83	90	85	82	10.0	6.6	23.3	55°	27,312		
25°	0° - 90°	1,489	100%	3	85	78	72	83	77	71	80	75	70	12.0	4.6	28.0	65°	16,017		
35°	90° - 180°	0	0%	4	76	68	62	75	67	62	72	66	61	14.0	3.4	32.7	75°	5,978		
45°	0° - 180°	1,489	100%	5	69	60	54	67	60	54	65	59	54	Beam Angle: 98.8°			85°	3,698		
55°		252		6	62	54	48	61	53	48	59	53	47	Field Angle: 137.4°						
65°		109		7	57	48	43	56	48	43	54	47	42							
75°		25		8	52	44	38	51	44	38	50	43	38							
85°		5		9	48	40	35	47	40	35	46	39	34							
90°		0		10	44	37	32	44	36	32	43	36	31							

WF6 DREG SM ALO20 SWW5 90CRI 40K Input Watts: 15.5, Delivered Lumens: 1500, LPW: 96.8, S/MH: 1.21, Test No: ISF 233012P4

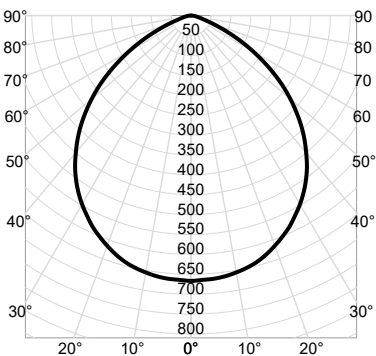

CP Summary	Zonal Lumen Summary				Coefficients of Utilization										Cone of Light			Luminance (cd/sq.m)		
	0°	Zone	Lumens	% Fixture	pf	pc	80%			20%			50%				Mounting Height	Initial FC Center Beam	Beam Diameter	Average Luminance
							50%	30%	10%	50%	30%	10%	50%	30%	10%					
0°	0° - 30°	513	34%	0	119	119	119	116	116	116	111	111	111	6.0	18.5	14.0	0°	41,368		
5°	0° - 40°	827	55%	1	107	103	100	105	101	99	100	98	95	8.0	10.4	18.7	45°	34,349		
15°	0° - 60°	1,353	90%	2	95	89	84	93	88	83	90	85	82	10.0	6.7	23.3	55°	27,513		
25°	0° - 90°	1,500	100%	3	85	78	72	83	77	71	80	75	70	12.0	4.6	28.0	65°	16,135		
35°	90° - 180°	0	0%	4	76	68	62	75	67	62	72	66	61	14.0	3.4	32.7	75°	6,022		
45°	0° - 180°	1,500	100%	5	69	60	54	67	60	54	65	59	54	Beam Angle: 98.8°			85°	3,726		
55°		254		6	62	54	48	61	53	48	59	53	47	Field Angle: 137.4°						
65°		110		7	57	48	43	56	48	43	54	47	42							
75°		25		8	52	44	38	51	44	38	50	43	38							
85°		5		9	48	40	35	47	40	35	46	39	34							
90°		0		10	44	37	32	44	36	32	43	36	31							

WF6 DREG SM ALO20 SWW5 90CRI 50K Input Watts: 15.5, Delivered Lumens: 1412, LPW: 91.1, S/MH: 1.21, Test No: ISF 233012P5

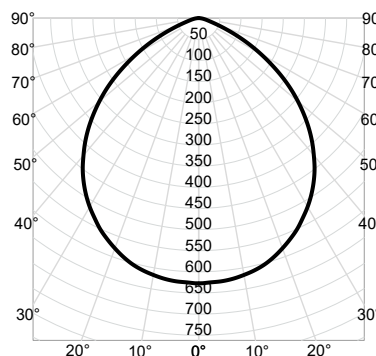

CP Summary	Zonal Lumen Summary				Coefficients of Utilization										Cone of Light			Luminance (cd/sq.m)		
	0°	Zone	Lumens	% Fixture	pf	pc	80%			20%			50%				Mounting Height	Initial FC Center Beam	Beam Diameter	Average Luminance
							50%	30%	10%	50%	30%	10%	50%	30%	10%					
0°	0° - 30°	483	34%	0	119	119	119	116	116	116	111	111	111	6.0	17.4	14.0	0°	38,941		
5°	0° - 40°	778	55%	1	107	103	100	105	101	99	100	98	95	8.0	9.8	18.7	45°	32,334		
15°	0° - 60°	1,274	90%	2	95	89	84	93	88	83	90	85	82	10.0	6.3	23.3	55°	25,899		
25°	0° - 90°	1,412	100%	3	85	78	72	83	77	71	80	75	70	12.0	4.4	28.0	65°	15,188		
35°	90° - 180°	0	0%	4	76	68	62	75	67	62	72	66	61	14.0	3.2	32.7	75°	5,669		
45°	0° - 180°	1,412	100%	5	69	60	54	67	60	54	65	59	54	Beam Angle: 98.8°			85°	3,507		
55°		239		6	62	54	48	61	53	48	59	53	47	Field Angle: 137.4°						
65°		103		7	57	48	43	56	48	43	54	47	42							
75°		24		8	52	44	38	51	44	38	50	43	38							
85°		5		9	48	40	35	47	40	35	46	39	34							
90°		0		10	44	37	32	44	36	32	43	36	31							